

2. 3D Printer Wiring Guide

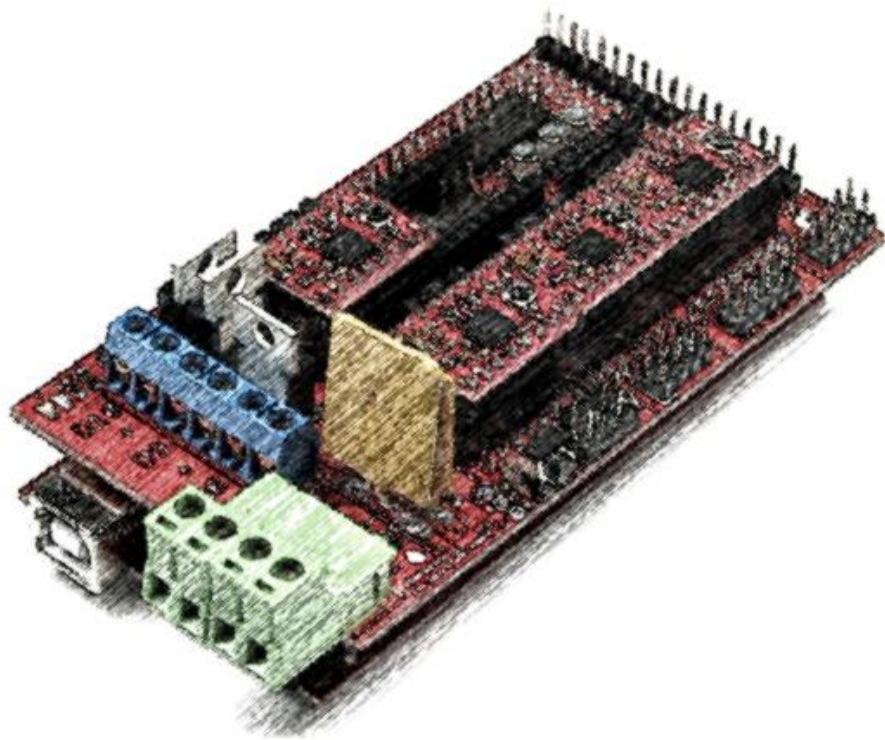

Content

2.1. Parts Required	3
2.2 preparation	7
2.2.1 Add heat sinks on the top of stepper motor driver chip.....	7
2.2.2 Plug the jumper cap into corresponding position	10
2.3 Wiring the main board part.....	11
2.3.1 Connect the stepper motor driver(A4988) to Ramp1.4.....	11
2.3.2 Reprap smart controller wiring	12
2.3.3 Connect Ramps1.4 to the main board.....	15
2.4 Wiring motors and limit switches.....	17
2.4.1 Wiring four stepper motors	19
2.4.2 Wiring the extruder.....	23
2.4.3 Wring limit switches.....	27
2.5 Connect power supply cables	32

2.1. Parts Required

Parts required:

- rep rap smart controller × 1
- ramps1.4 × 1
- MEGA2560 compatible board × 1
- Stepper motor driver(A4988) × 4

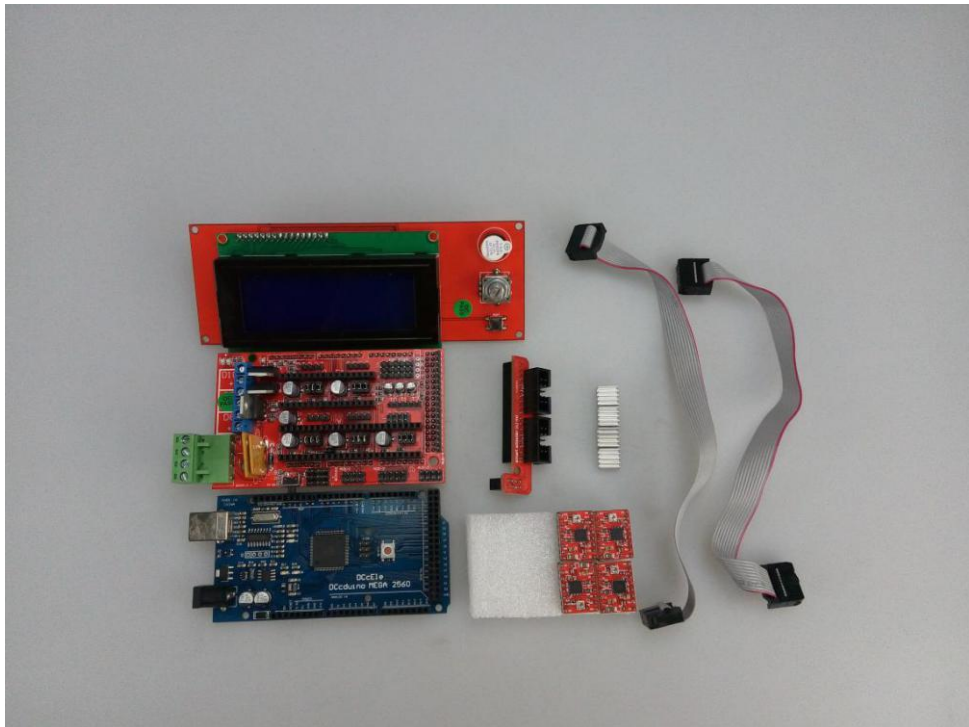

Mega2560 compatible board

Based on the ATmega2560 and used as the microcontroller board of our 3D printer.

Makeblock Constructor I 3D Printer Kit



Ramps1.4 Shield

Ramps is short for reprop Arduino mega pololu shield, it is open source and designed as the shield of 3D printer. For more details about this open source hardware design can be found on the Reprap Wiki here:http://reprap.org/wiki/RAMPS_1.4.

Makeblock Constructor I 3D Printer Kit

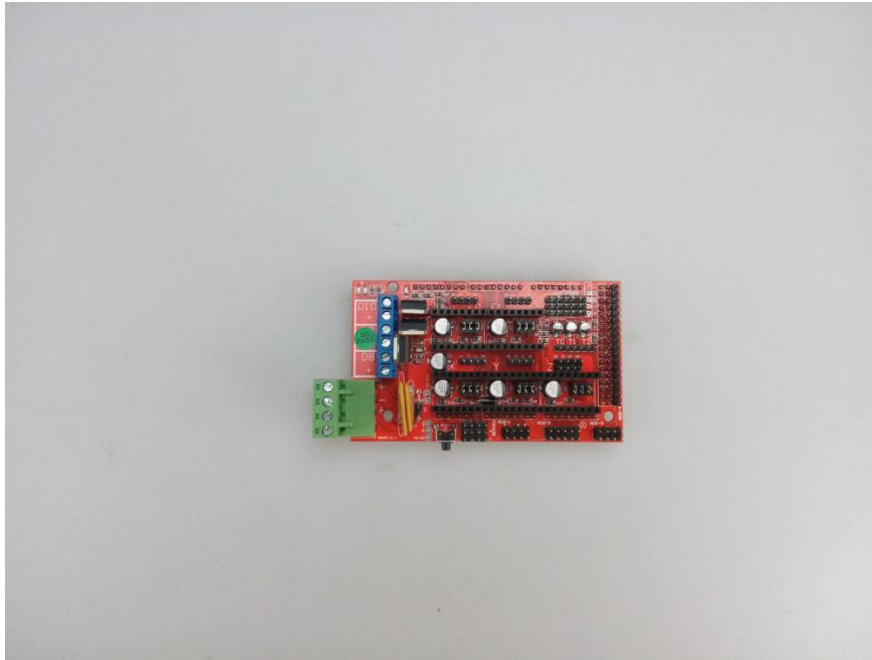

reprap smart controller

Used as LCD display of Constructor I 3D printer, you can easy connect it to your Ramps using the "smart adapter". It is open source and you can know more details from here http://reprap.org/wiki/RepRapDiscount_Smart_Controller



Makeblock Constructor I 3D Printer Kit

Smart adapter



Stepper Motor Driver Module (A4988) Pictures are for reference only, please in kind prevail

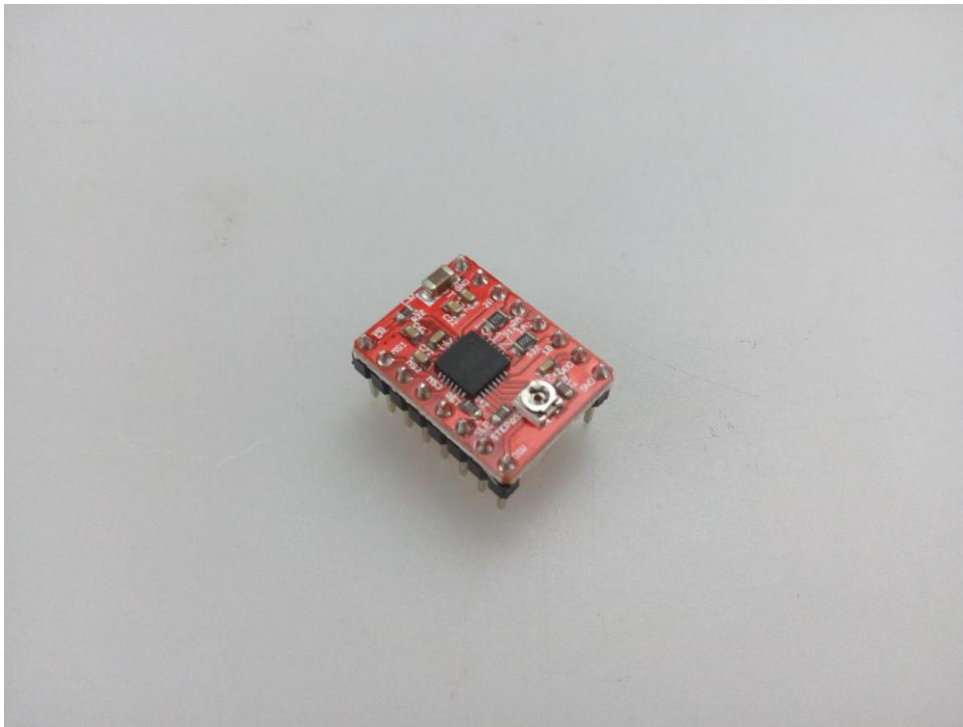

Heat sink for stepper motor driver chip



2.2 preparation

2.2.1 Add heat sinks on the top of stepper motor driver chip

Use scissors for cutting open the tape



Makeblock Constructor I 3D Printer Kit

Cut the tape as the same size as heatsink



Stick the tape to the heat sink

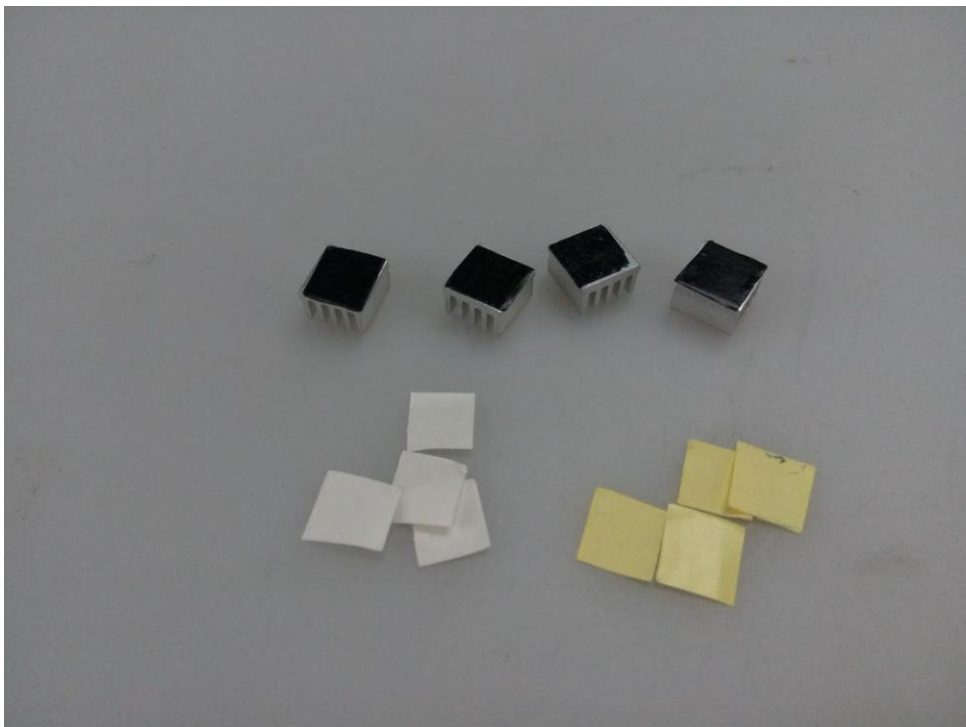

Makeblock Constructor I 3D Printer Kit

Stick the heatsink to Chip A4988 firmly

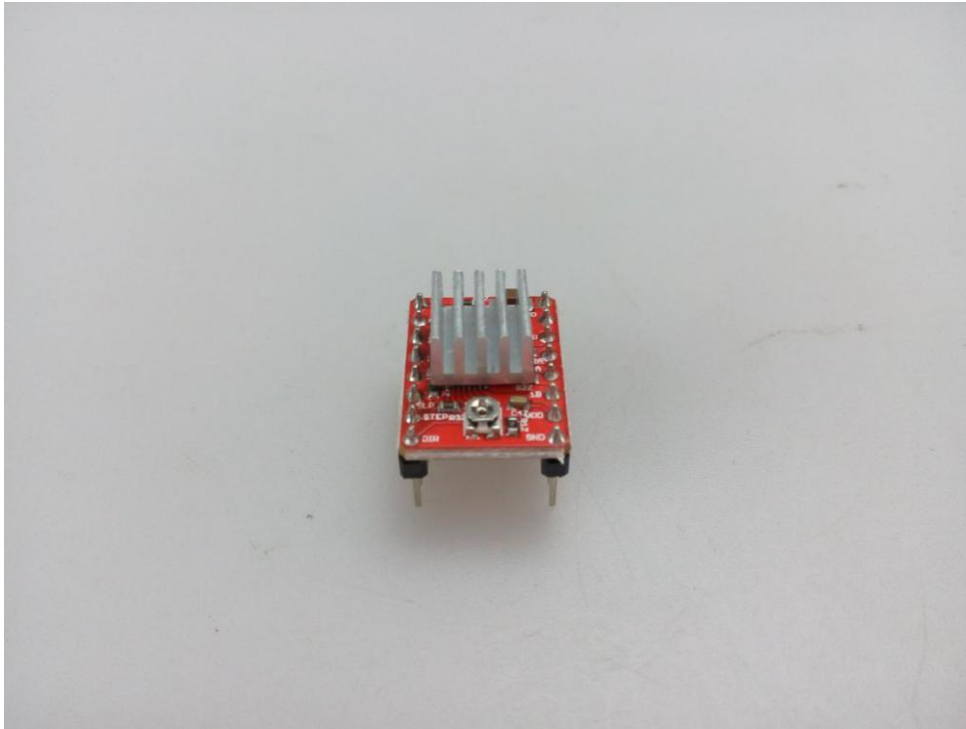

Repeat the above step to stick other 3 modules

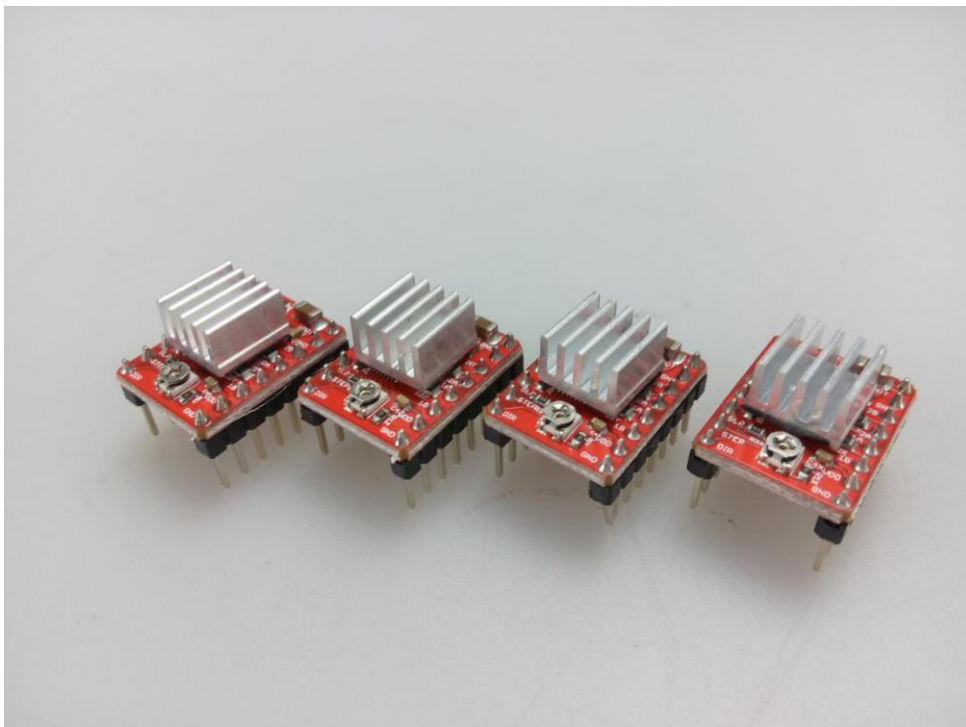

2.2.2 Plug the jumper cap into corresponding position

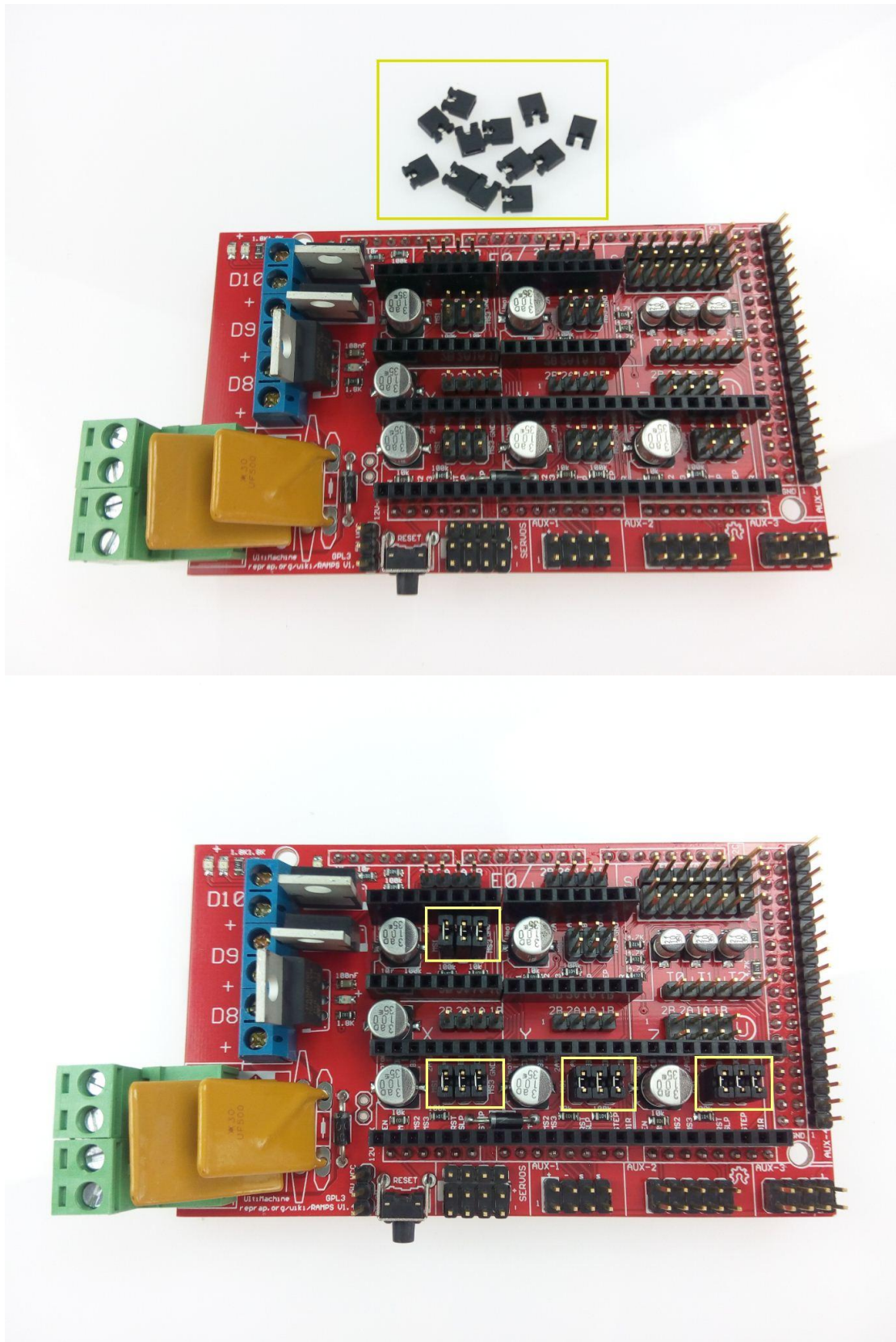

2.3 Wiring the main board part

2.3.1 Connect the stepper motor driver(A4988) to Ramp1.4.

step1. Plug in the A4988 motor driver module onto Ramp1.4 as shown below.

(ATTENTION: IF ANTI-PLUG, IT WILL SHORT-CIRCUITS.)

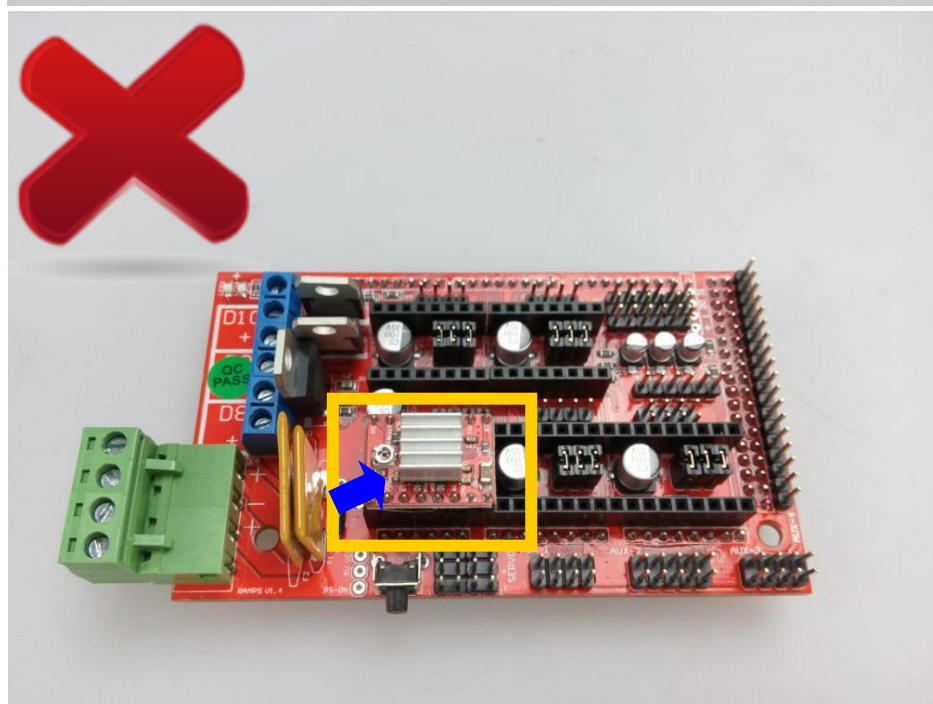
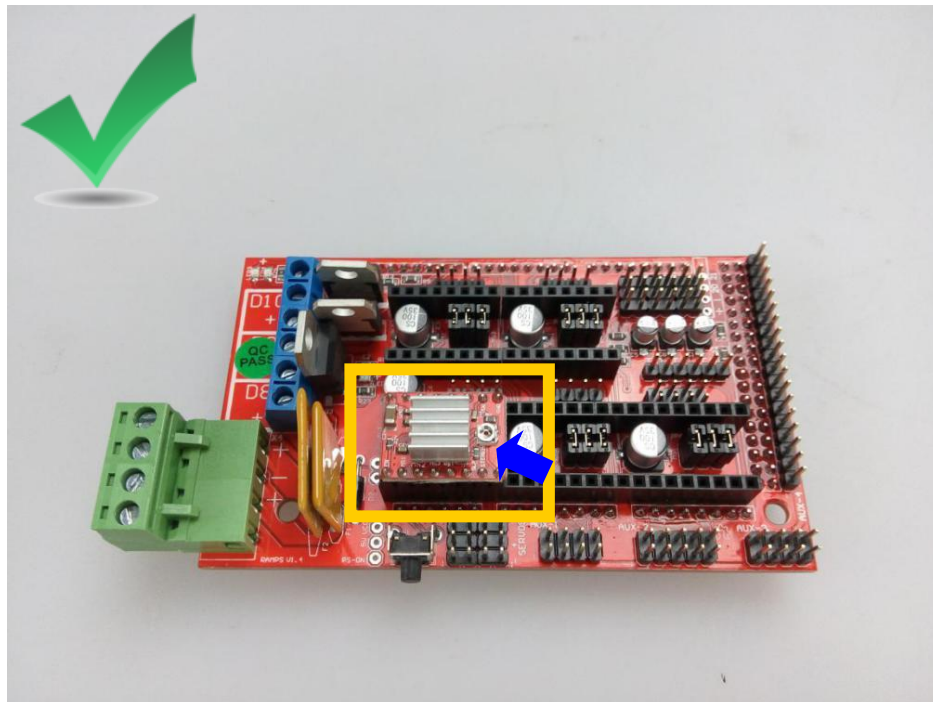

Makeblock Constructor I 3D Printer Kit

step2. Plug the following 4 motor driver modules onto the board, make sure the pins insert the female header.

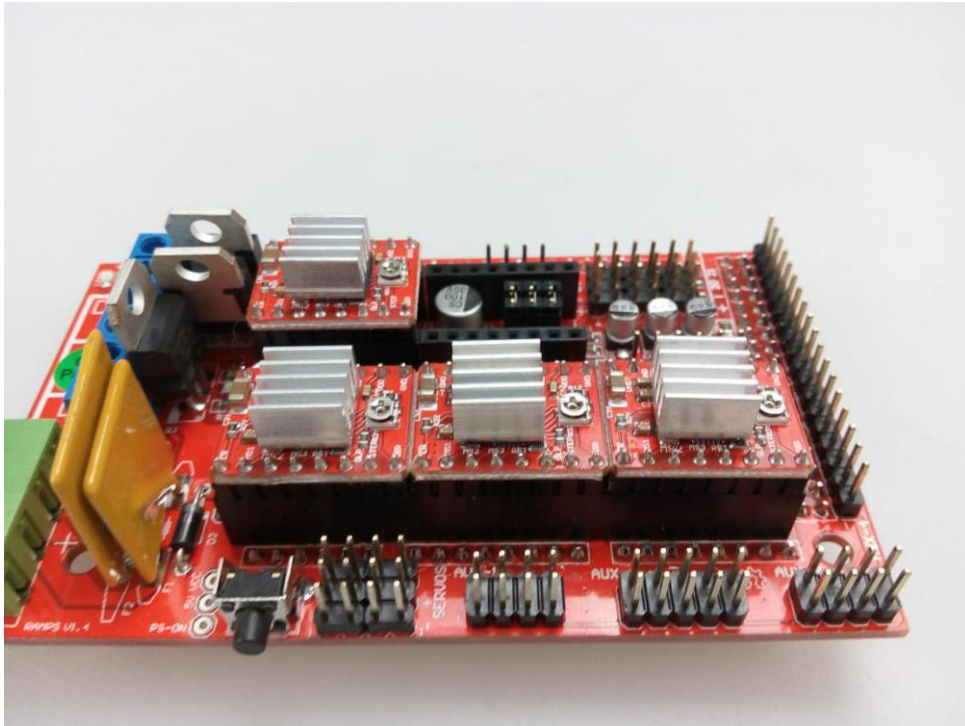

2.3.2 Reprap smart controller wiring

Required parts is shown below.

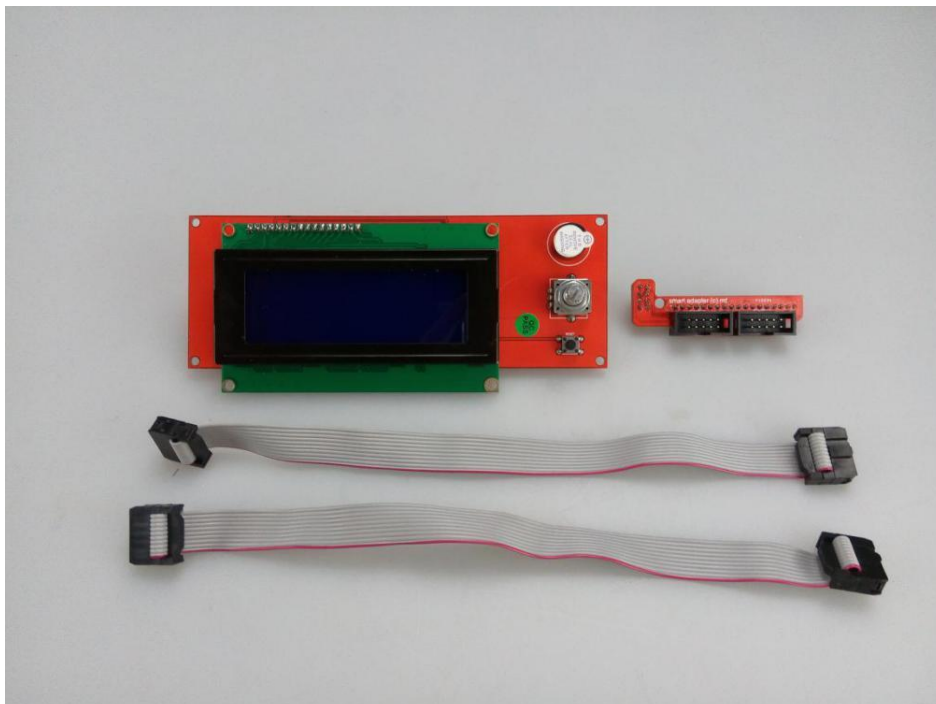

Makeblock Constructor I 3D Printer Kit

Step 1. Wiring the smart adapter

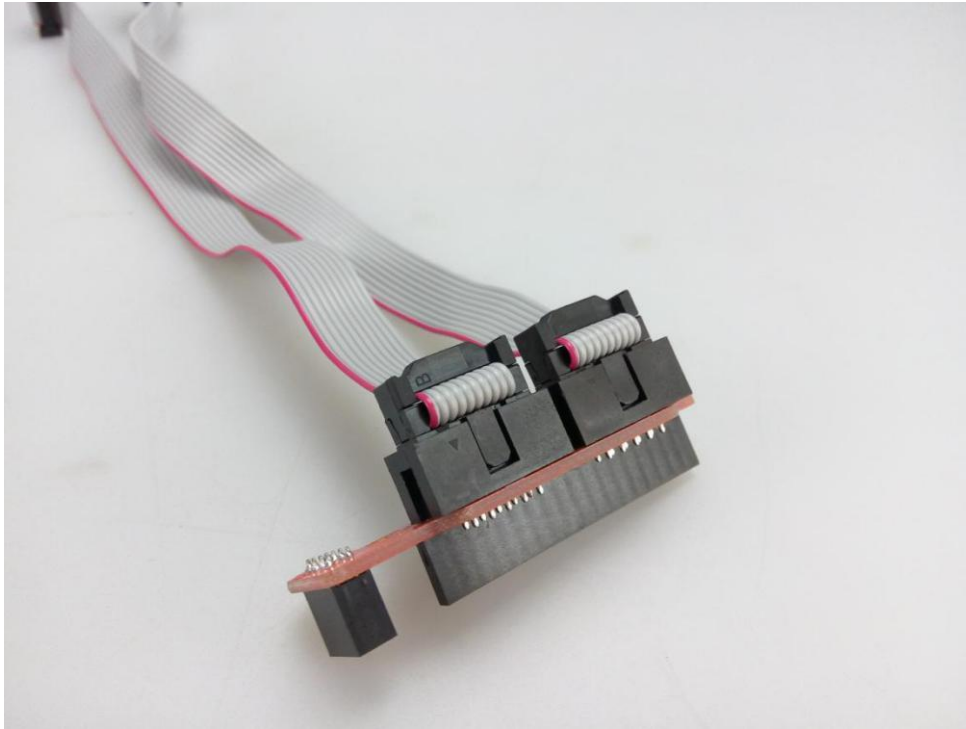

Step 2. Wiring the other end to LCD module

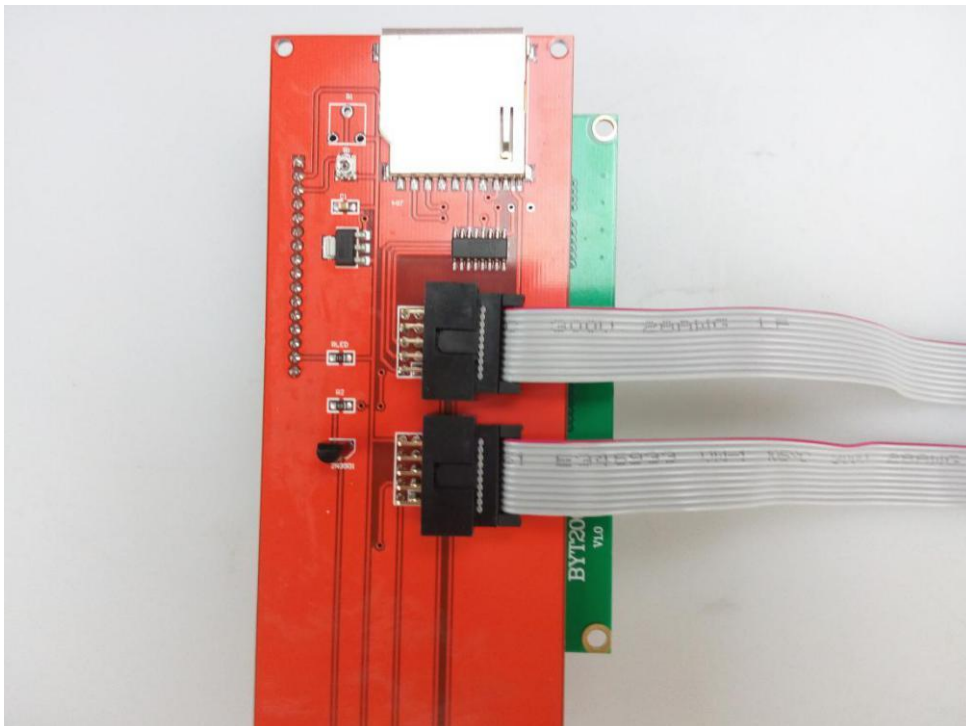

Makeblock Constructor I 3D Printer Kit

Step 3. Connect the LCD adapter to Ramp1.4

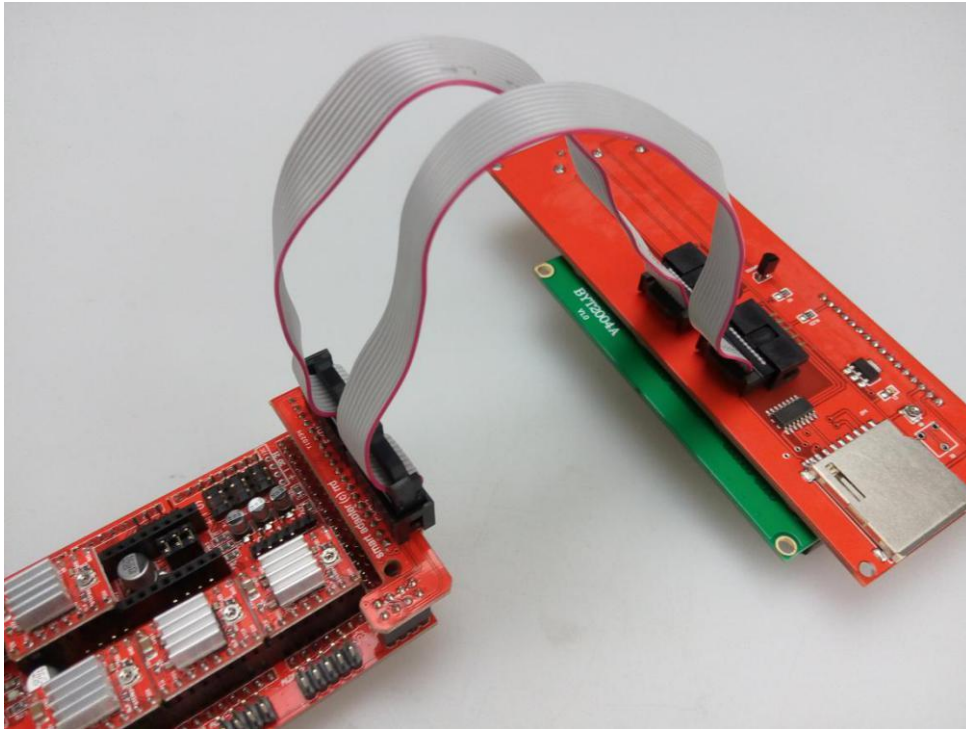

Step 4. Please double-check if all the modules plug into the female header.

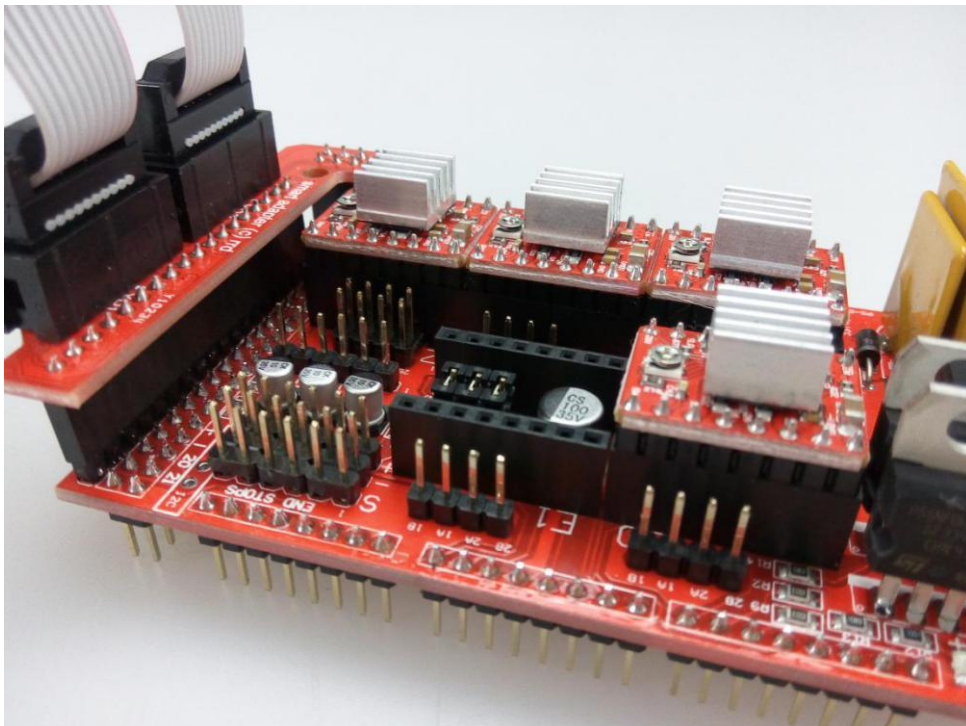

2.3.3 Connect Ramps1.4 to the main board

Step 1. Install the Ramps1.4 on the top of Mega2560 compatible board, ragged the right side female header and plug in slowly.

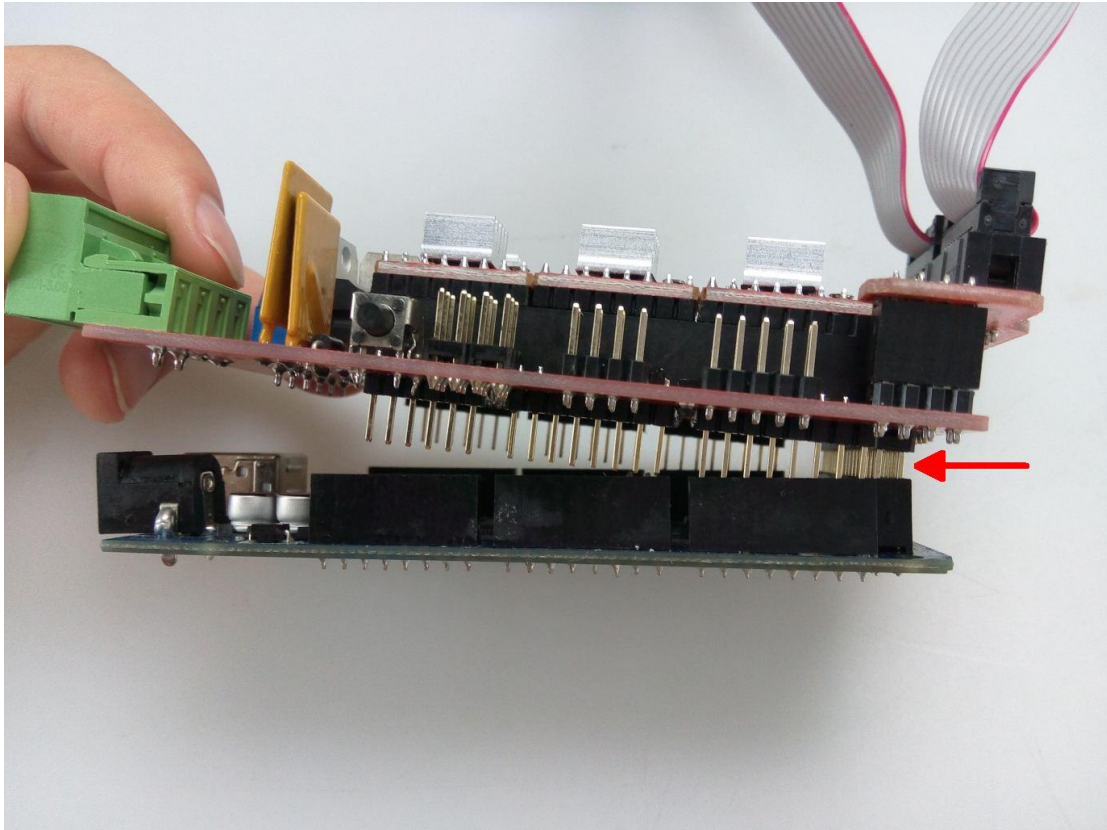

Step2. Double check if all the connections are right.

Makeblock Constructor I 3D Printer Kit

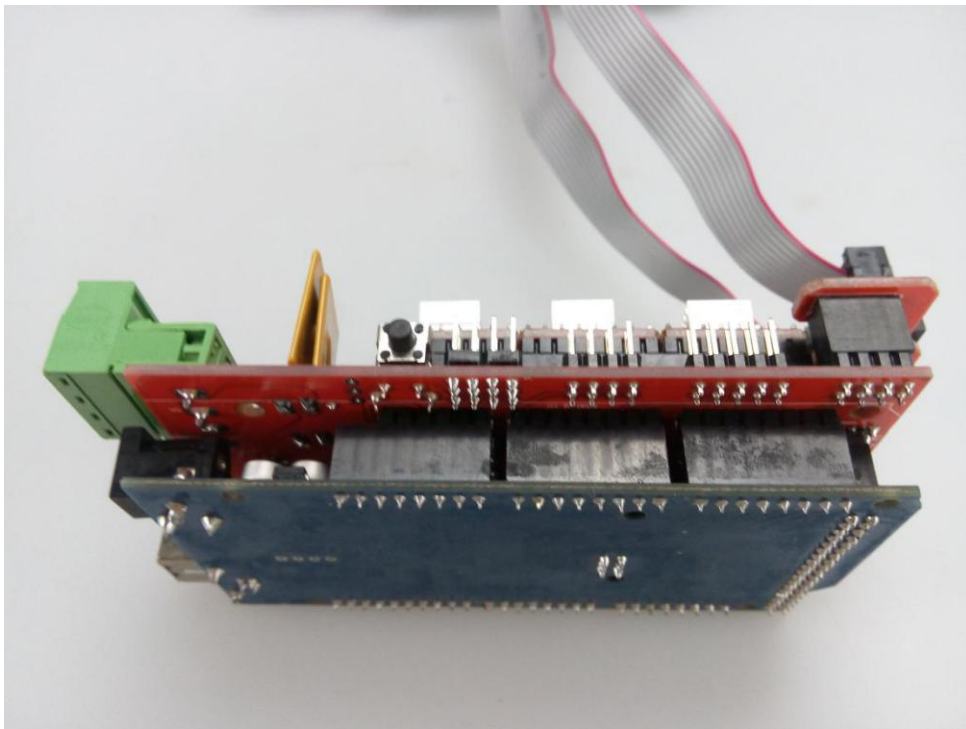
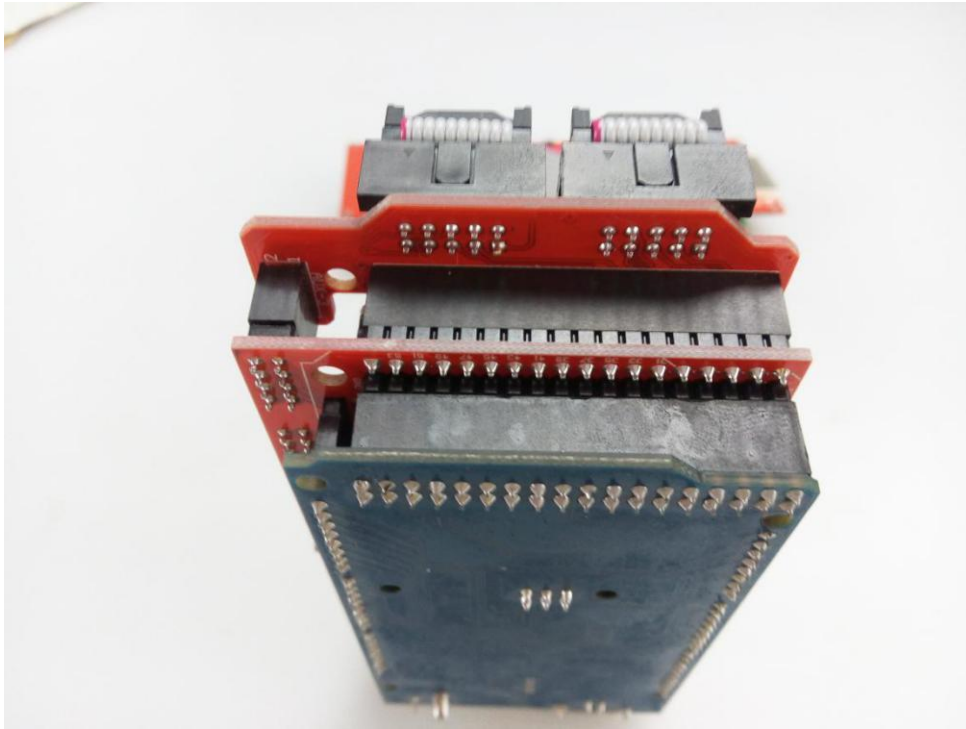

The main board part is complete! We need to wire the motor wire, end stop and power cables.

2.4 Wiring motors and limit switches

Electronic wiring as show, this is RepRap original wiring figure and please follow the actual image to wire. (Because Makeblock Constructor I 3D Printer Kit do not contain Heated Bed, you don' t need to wire Heated Bed Power and Heated Bed Thermistor.). Kindly advise you can pay more attention and carefully to avoid faulty connection.

Note: Please connect the motor wiring as following order: red, blue, green and black.

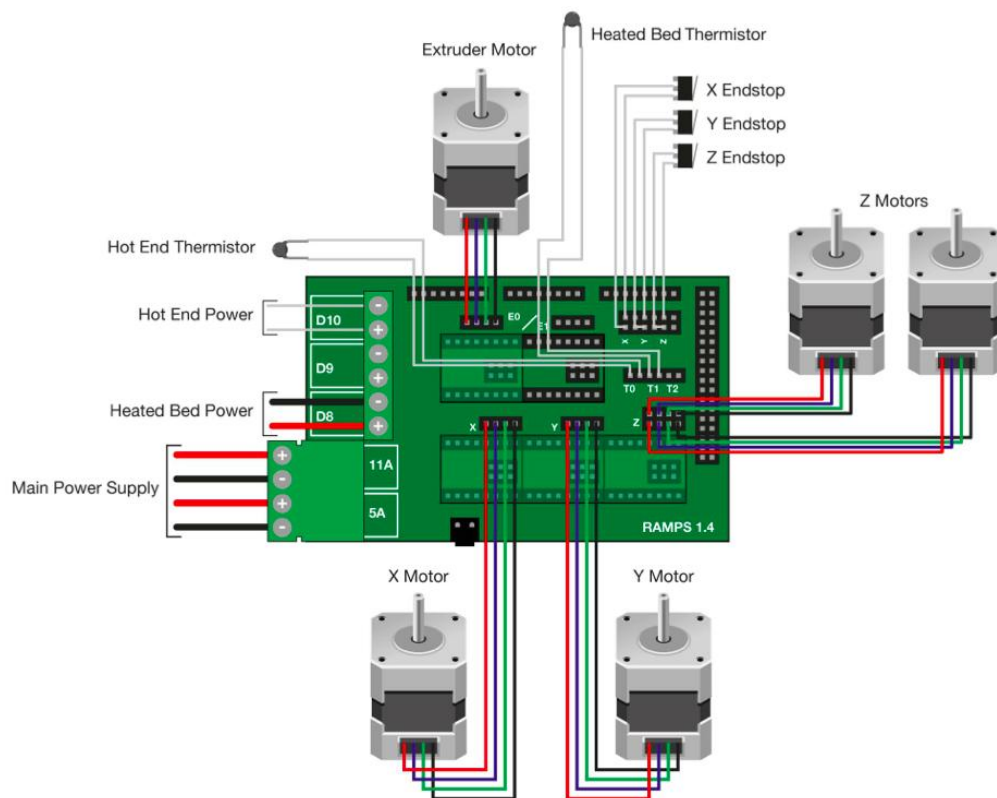

Makeblock Constructor I 3D Printer Kit

Figure out and remember the position of X/Y/Z motor and every end stop, BE

CAREFUL not to mix up the end stop.

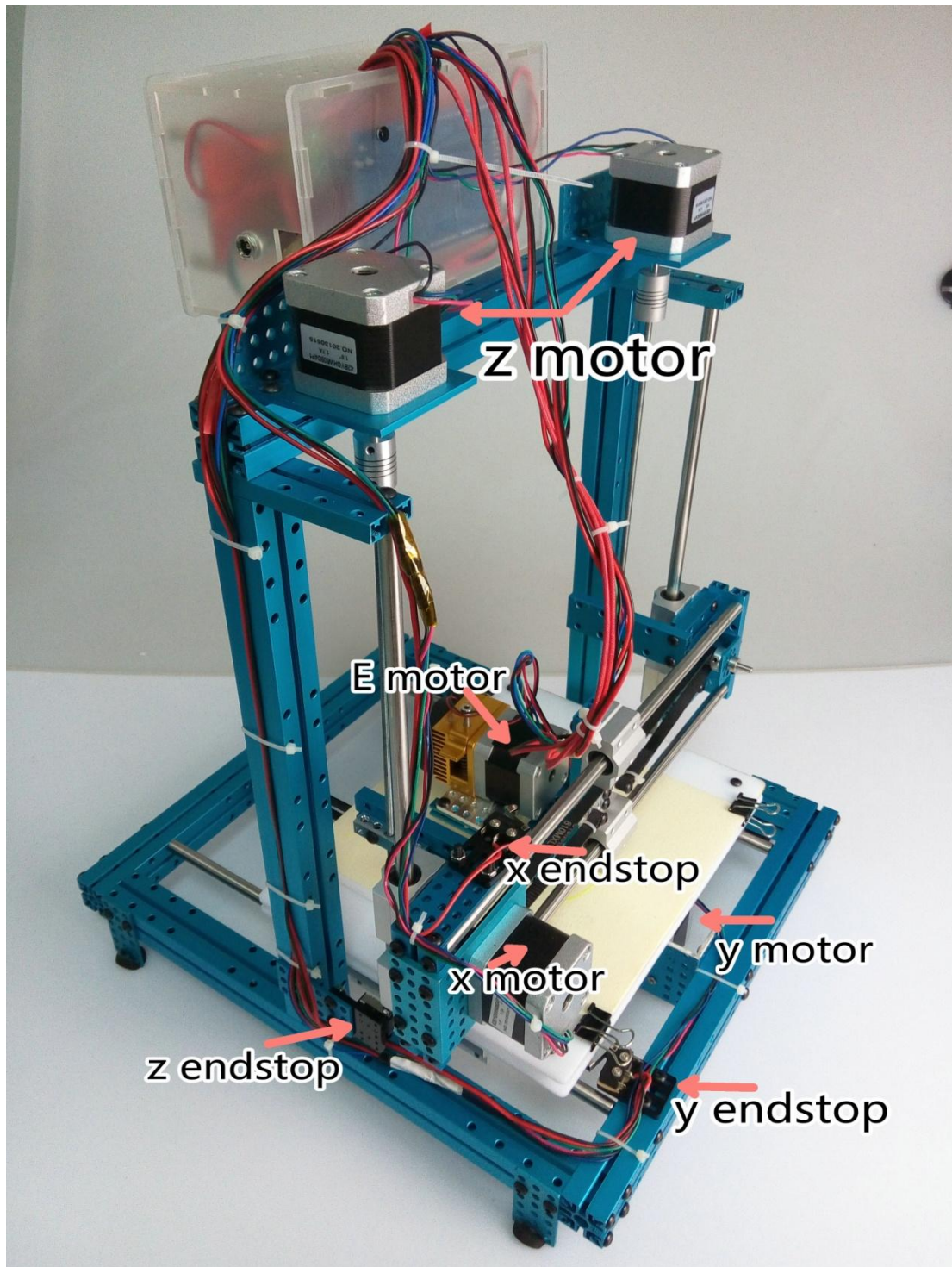

2.4.1 Wiring four stepper motors

Step1. Connect the X Motor to the connector labeled X. Ensure the Red cable is closest to the green screw terminals on the RAMPS board (Wire orders from left to right: red, blue, green and black).

Note: If you don't wiring by color order, the motor motion will be incorrect.

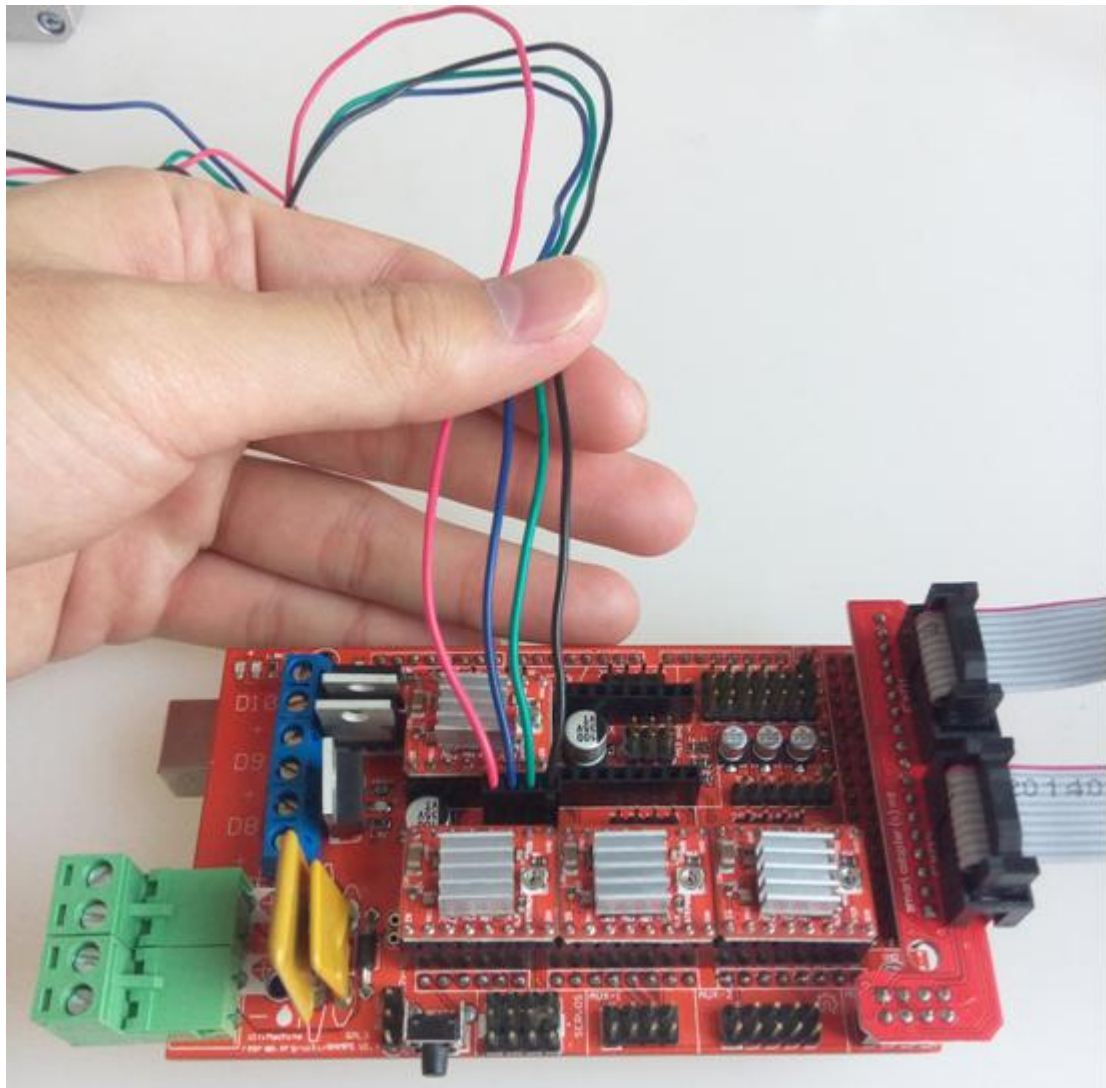

Step 2. Connect the Y Motor to the connector labeled Y. Ensure the Red cable is closest to the green screw terminals on the RAMPS board. (Wire orders from left to right)

Makeblock Constructor I 3D Printer Kit

right: red, blue, green and black)

Note: If you don't wiring by color order, the motor motion will be incorrect.

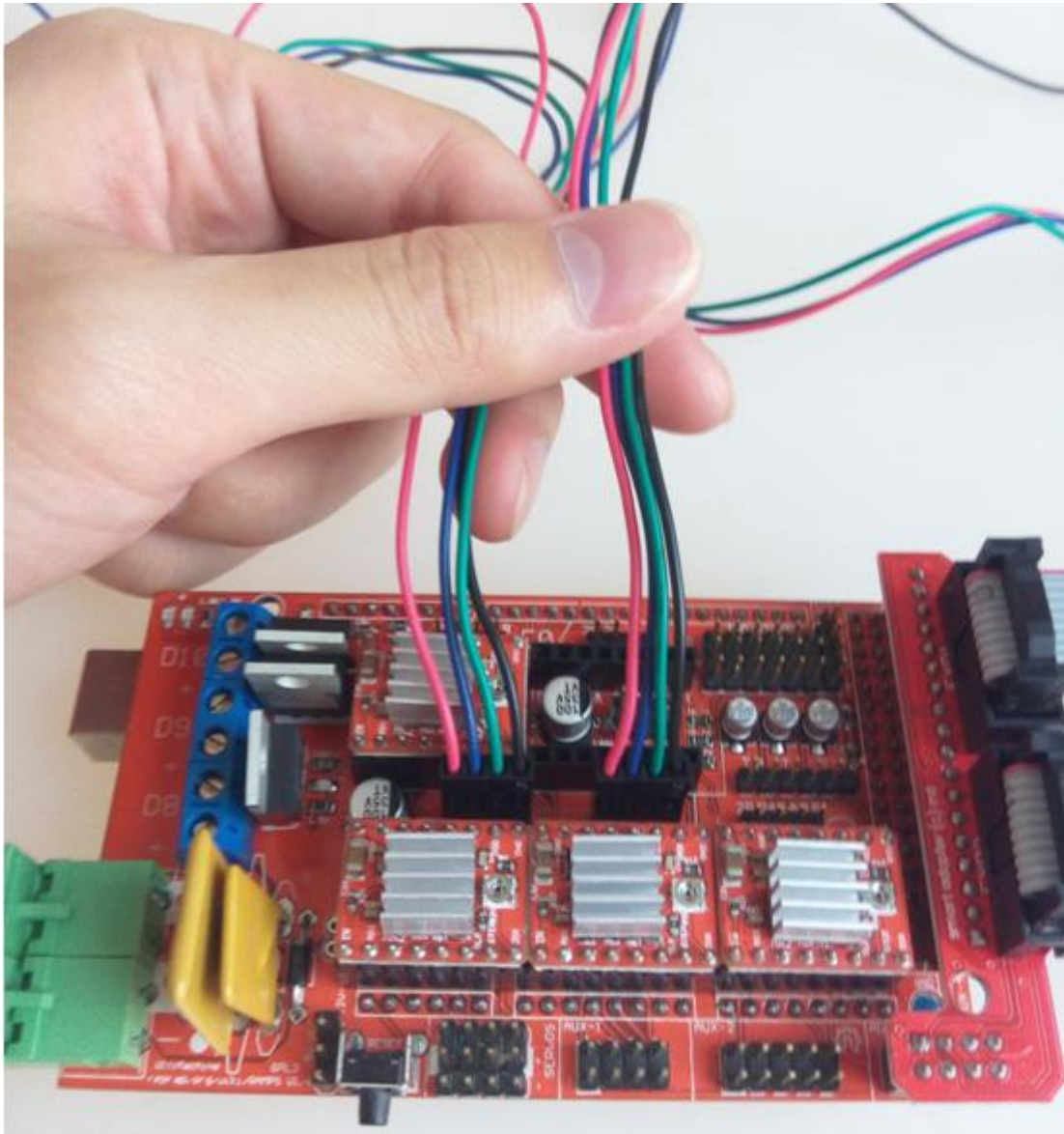

Step 3. Check the double-row header area around Z motor driver on the Ramp1.4 board. It can connect 2 Z motors of 3D printer.

Makeblock Constructor I 3D Printer Kit

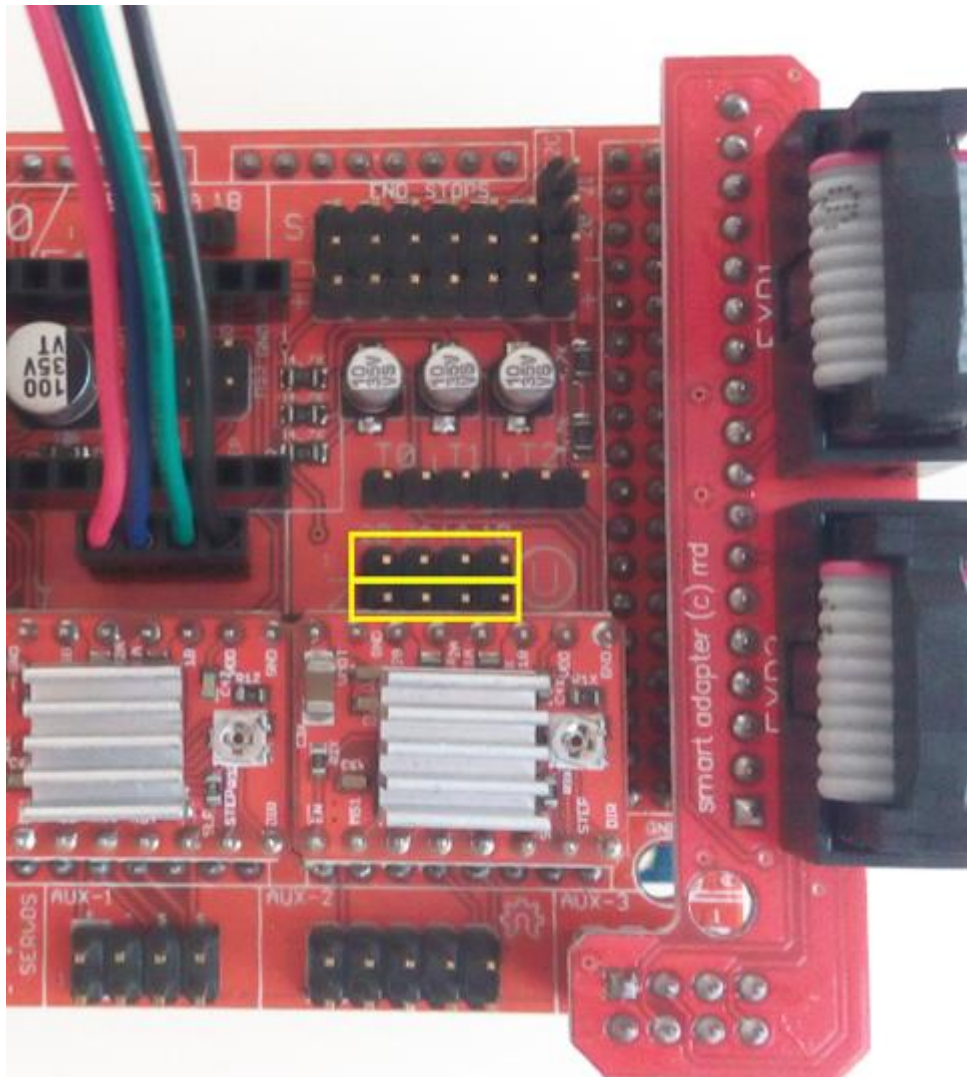

Step 4. Connect the two Z Motors to connectors labeled Z. Ensure the Red cable is closest to the green screw terminals on the RAMPS board. (Wire orders from left to right: red, blue, green and black).

Makeblock Constructor I 3D Printer Kit

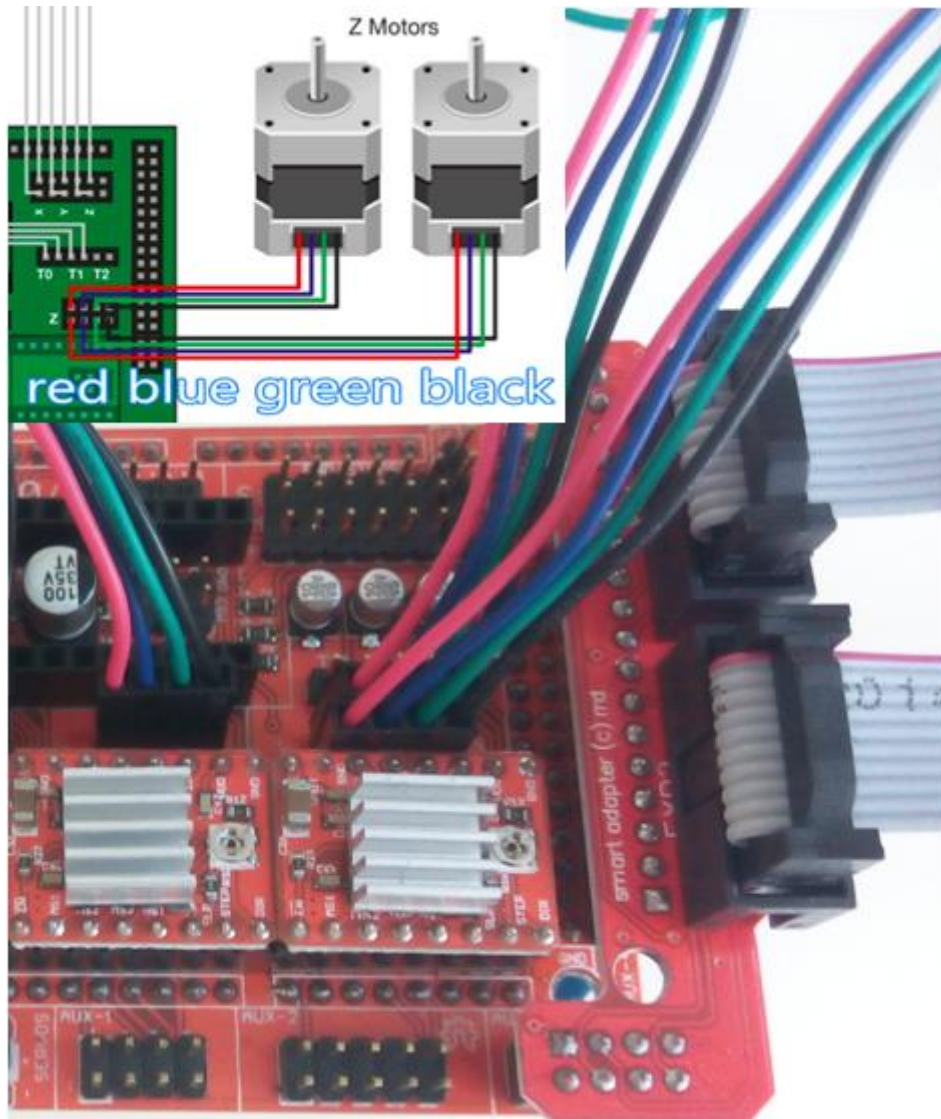

2.4.2 Wiring the extruder

Check the all components of extruder.

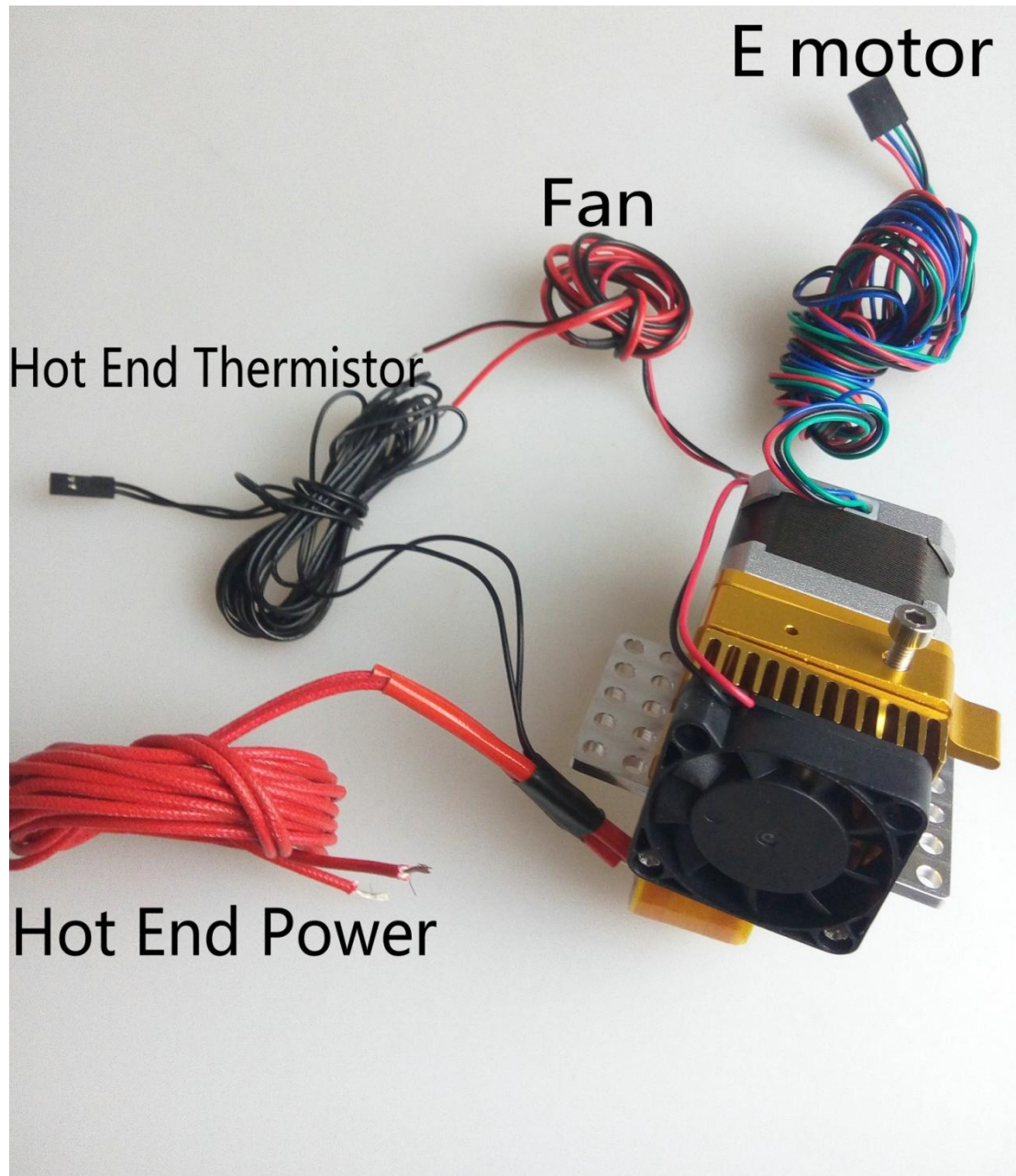

Makeblock Constructor I 3D Printer Kit

Step 1. Connect the Extruder Motor to the connector labeled E0. Ensure the Red cable is closest to the green screw terminals on the RAMPS board(Wire orders from left to right: red, blue, green and black).

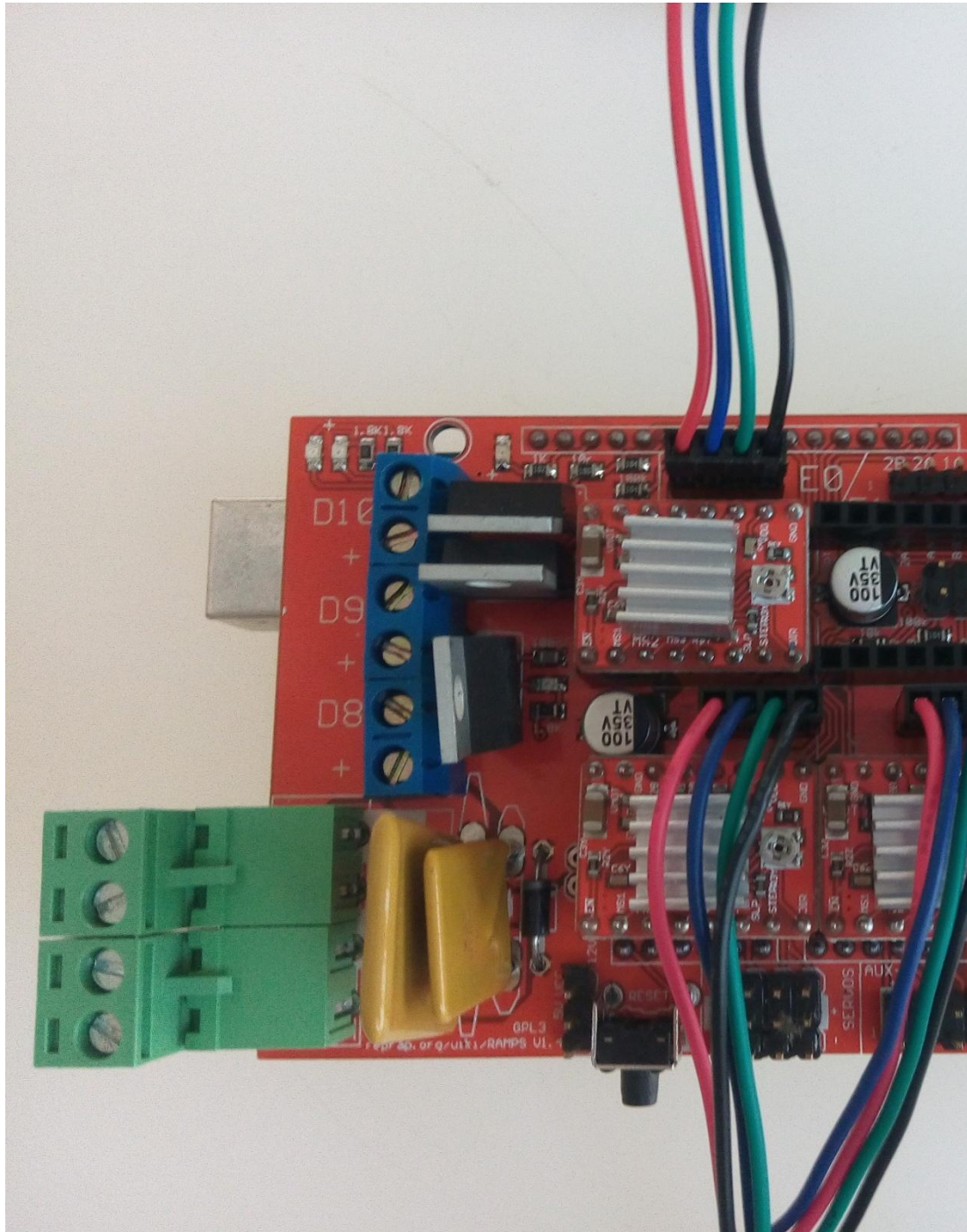

Makeblock Constructor I 3D Printer Kit

Step 2. The two red wires from extruder heating pipe have no positive and negative difference.

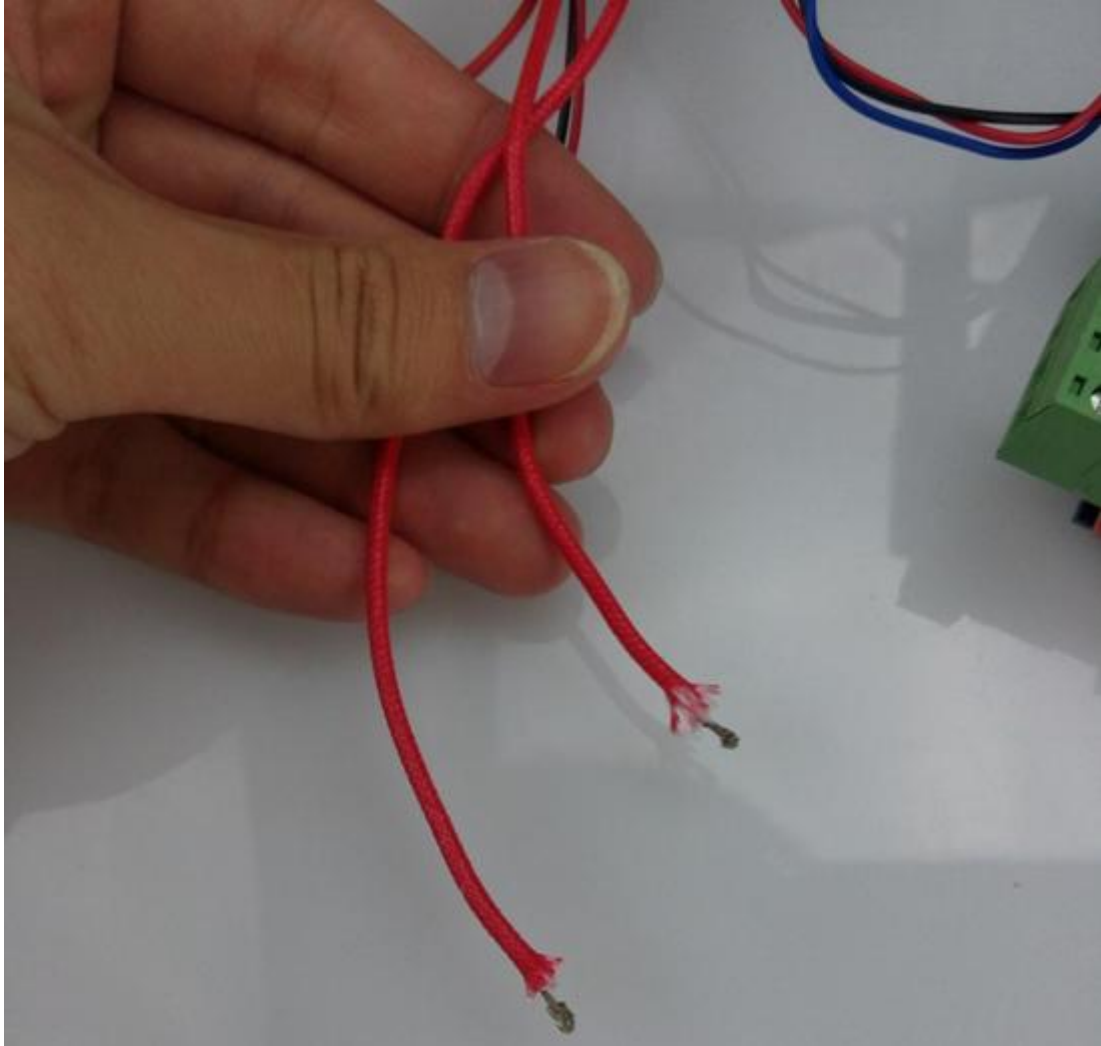

Connect the wire to D10, make sure the screw clamp the wire, or else the heater will not heat up.

Makeblock Constructor I 3D Printer Kit

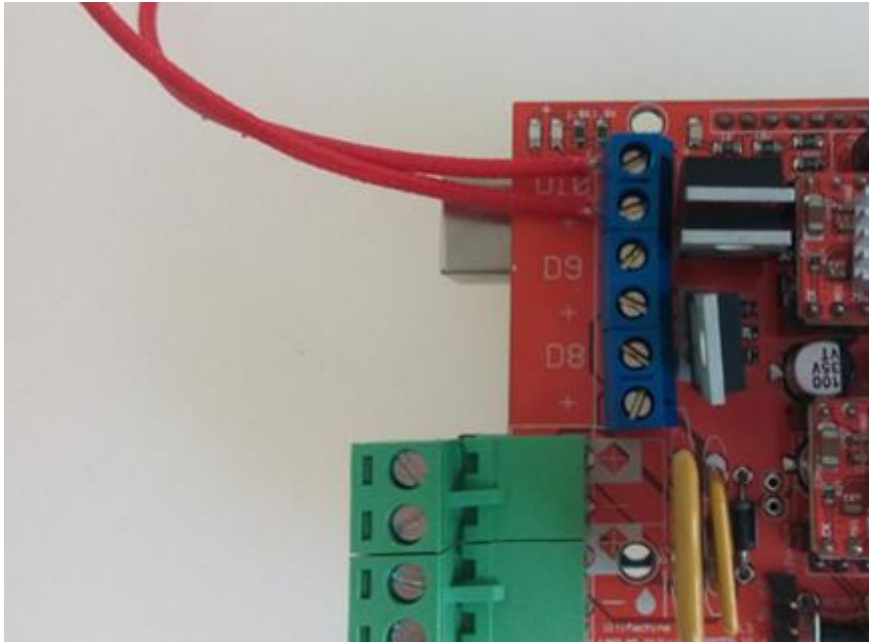

Step 3. The thermocouples lead wires of extruder has no positive and negative difference as well. You need to connect the lead wires to T0 for detecting temperature of extruder heater.

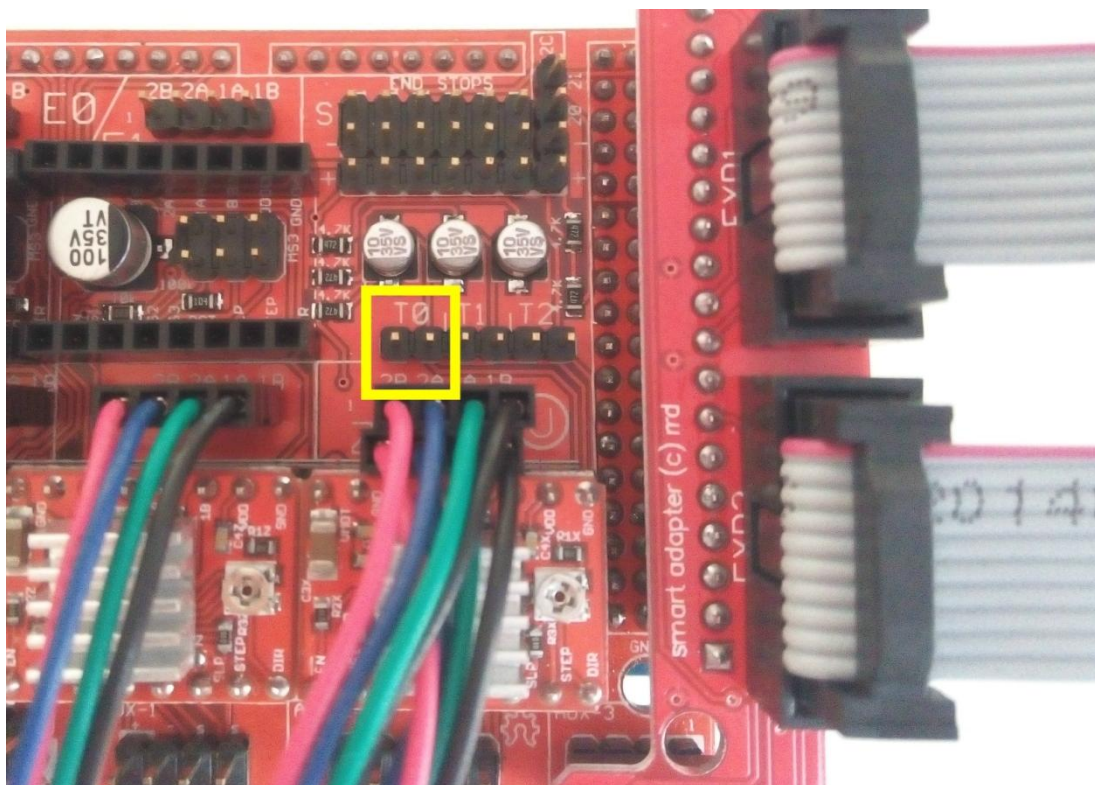

Makeblock Constructor I 3D Printer Kit

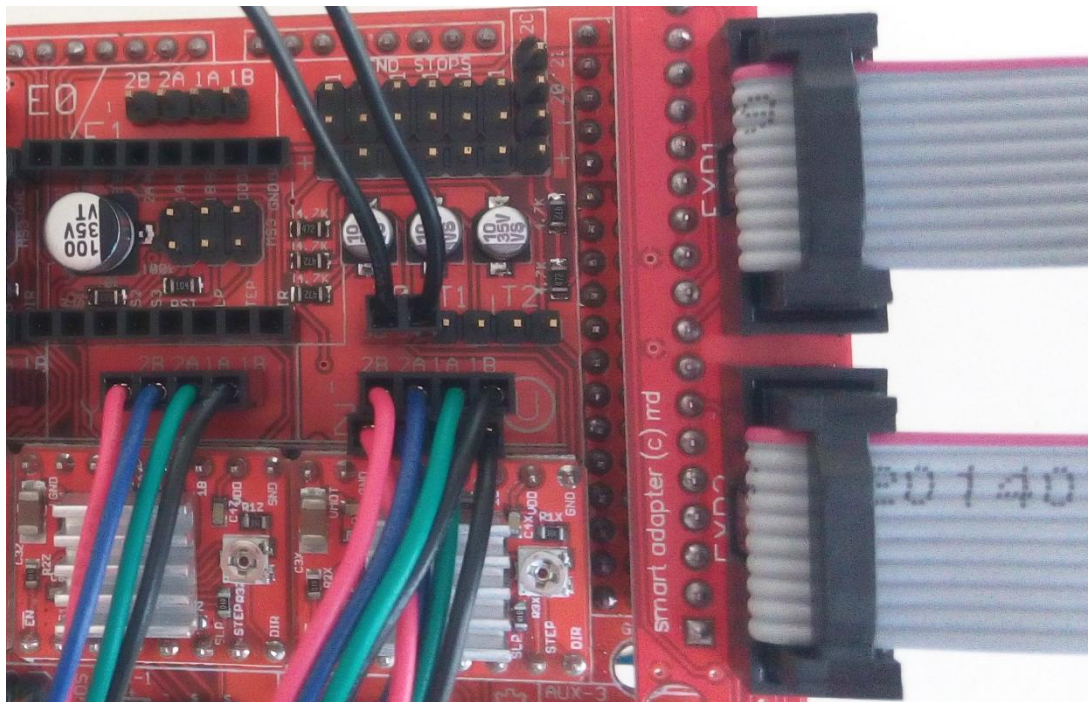

2.4.3 Wring limit switches

Note: Please connect limit switches to the male header (Area "S" and "-").

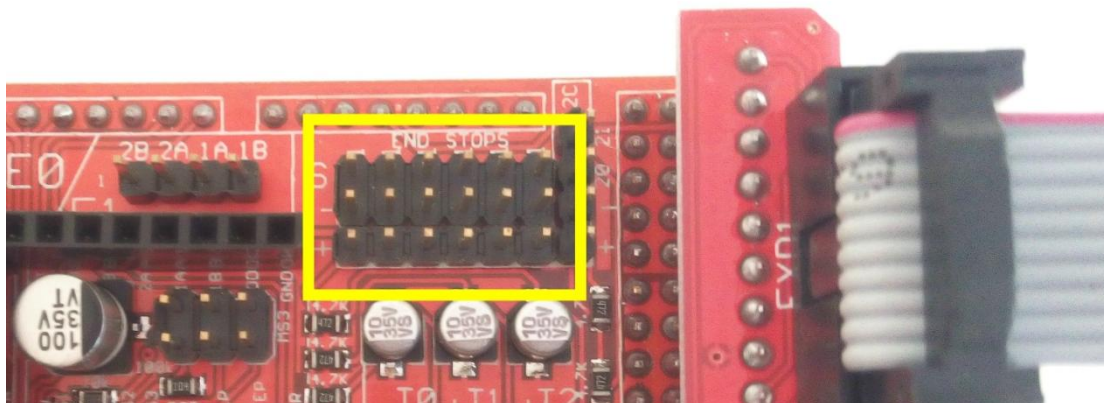

Makeblock Constructor I 3D Printer Kit

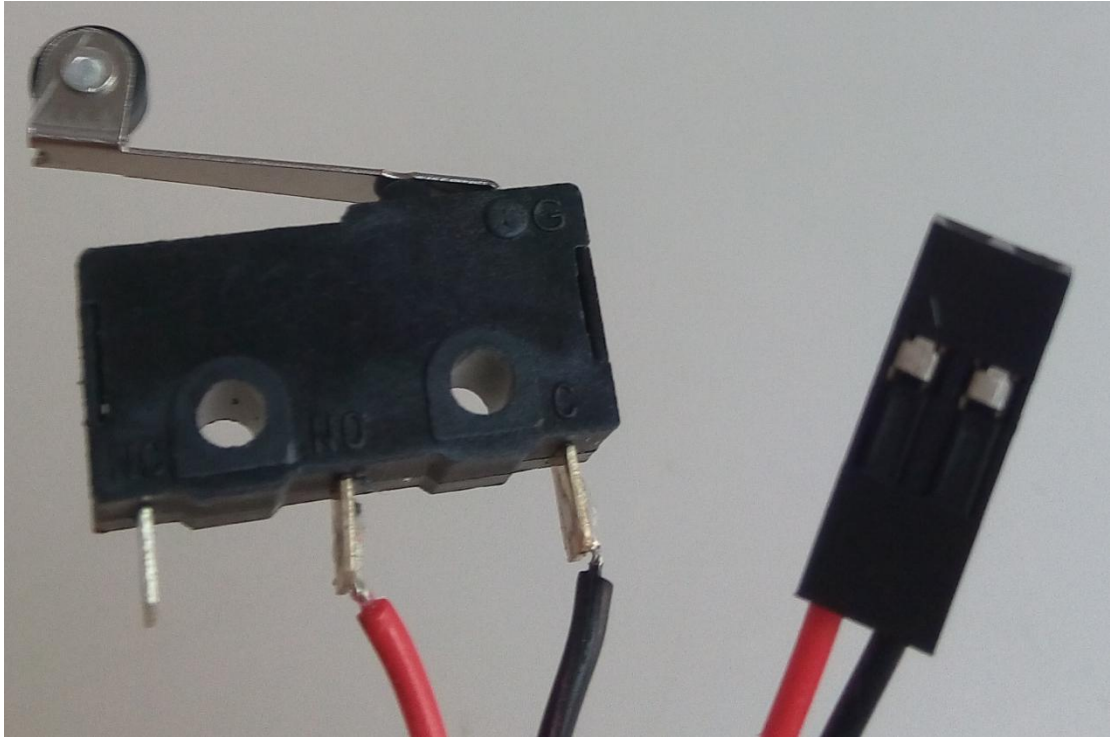

Step 1. Connect the X Endstop Micro switch to the connector labeled **x+**. (Area "S" and "-" on the board, you can connect "S" or "-" in any order.

)

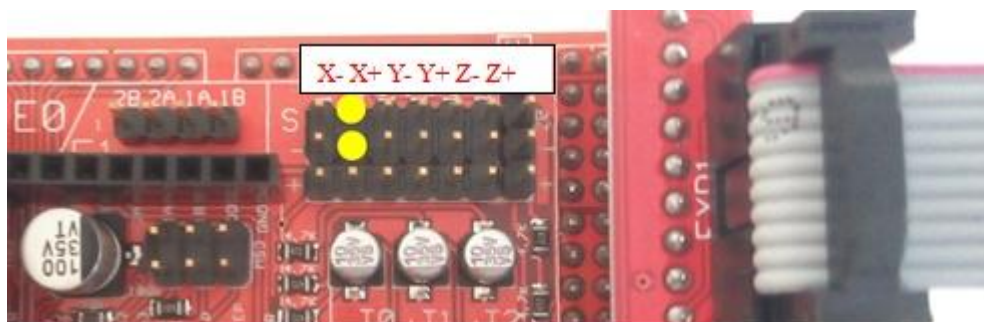

Makeblock Constructor I 3D Printer Kit

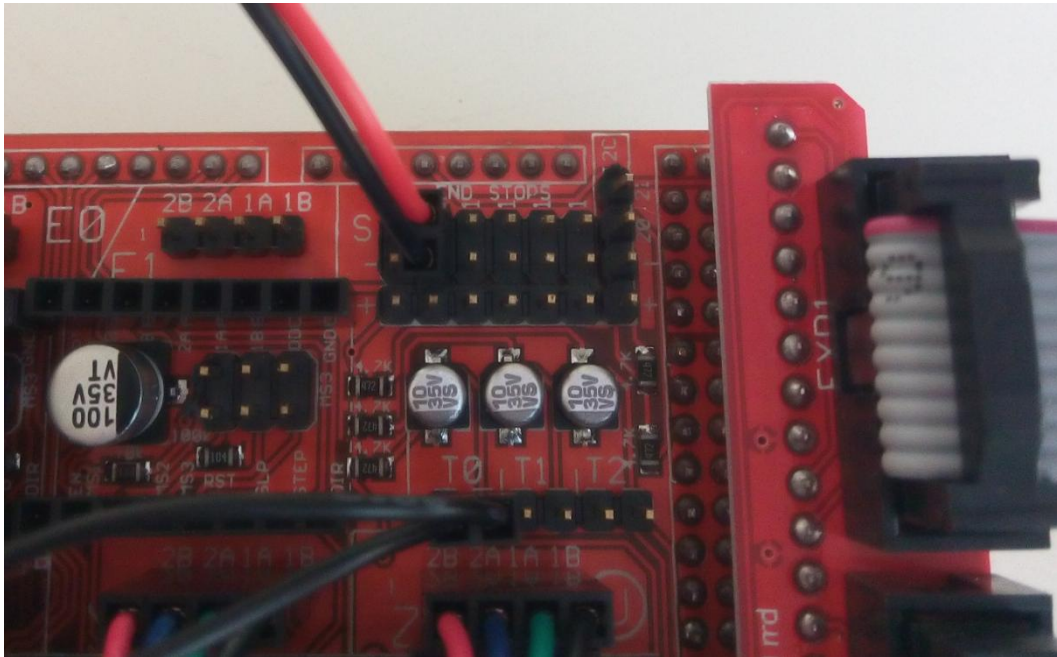

Step 2. Connect the Y Endstop Microswitch to the connector labeled **y-**

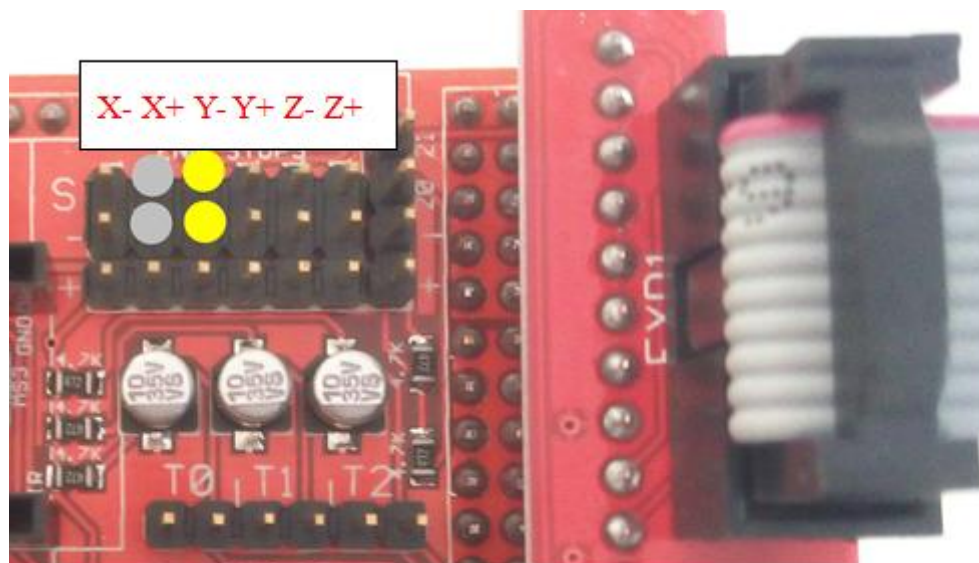

Makeblock Constructor I 3D Printer Kit

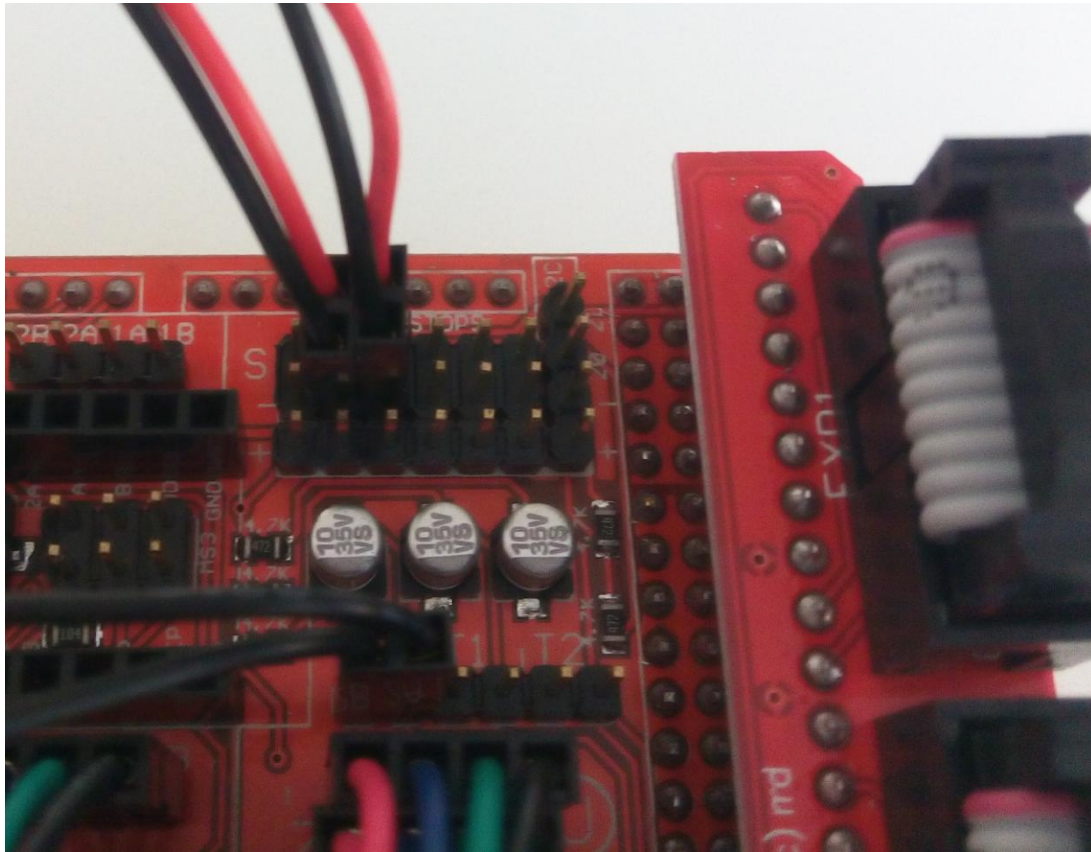

Step 3. Connect the Z Endstop Microswitch to the connector labeled **z-**

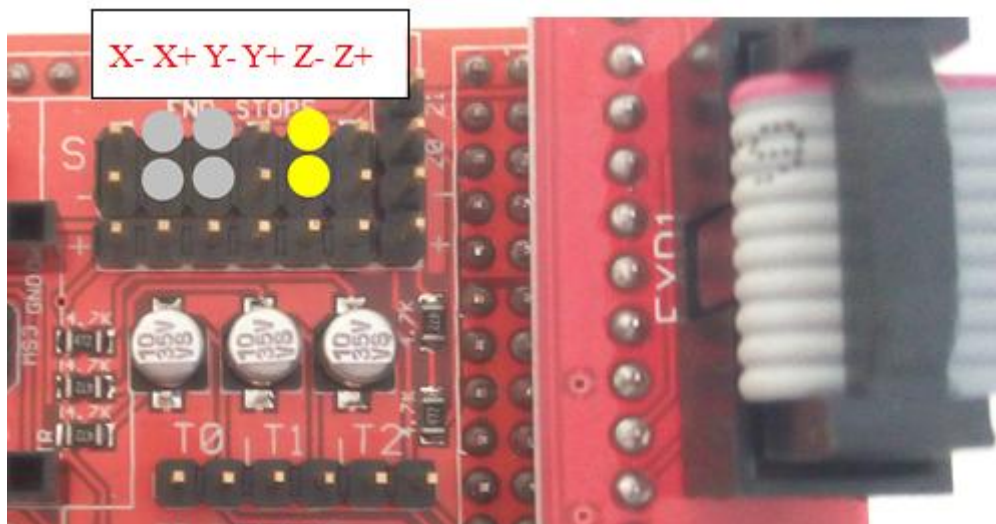

Makeblock Constructor I 3D Printer Kit

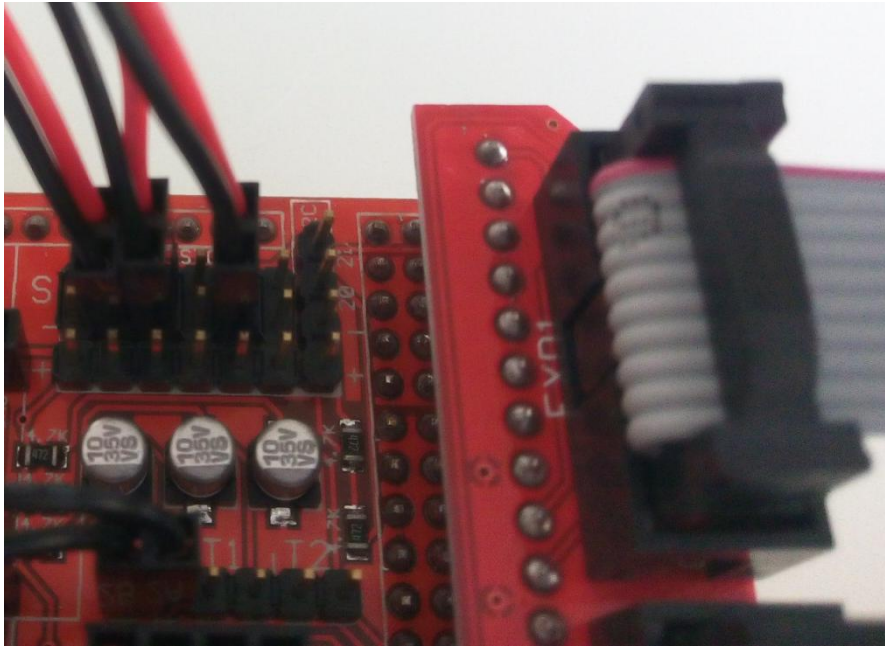

Step 4. Please check the stop end X/Y/Z connect X+/Y-/Z- connection order carefully. IF THE CONNECTIONS ARE INCORRECT, THE MACHINE WON' T STOP MOVEMENT WHILE RETURN TO ZERO. If the machine won' t stop moving, please check if the end stop connection is correct.

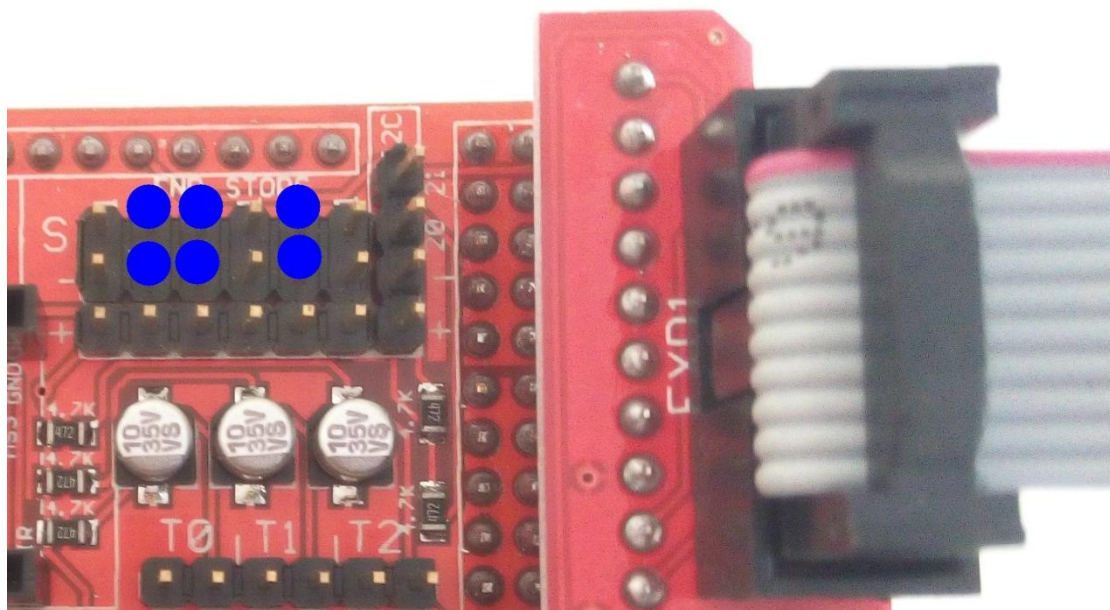

Makeblock Constructor I 3D Printer Kit

2.5 Connect power supply cables

Notice the positive and negative difference.

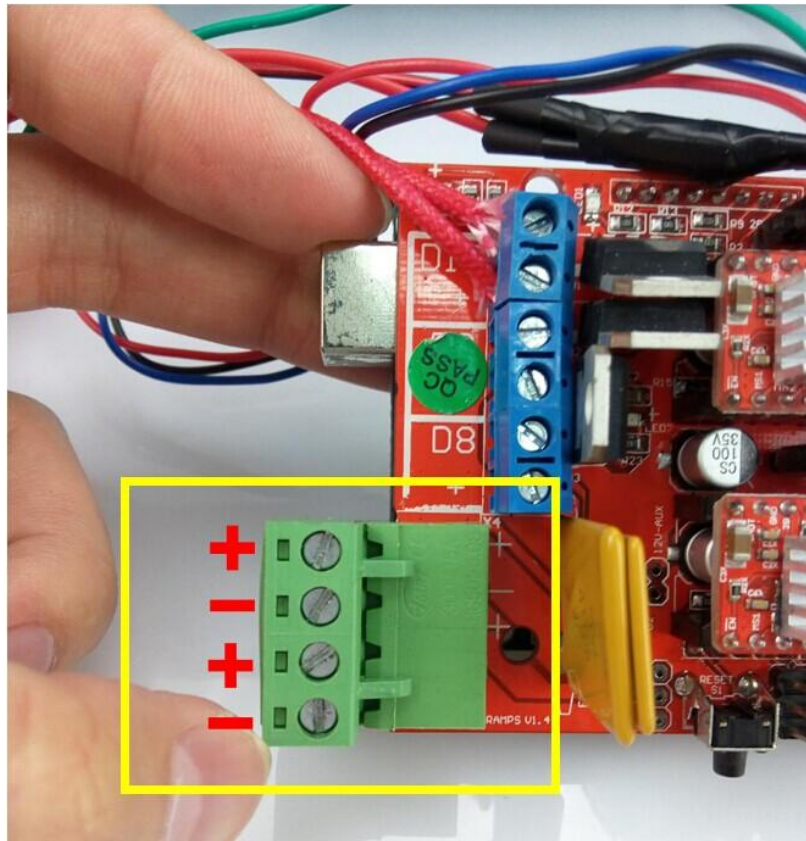

Notice: we have updated the version of plug like pictures below, please make sure you connect correctly.

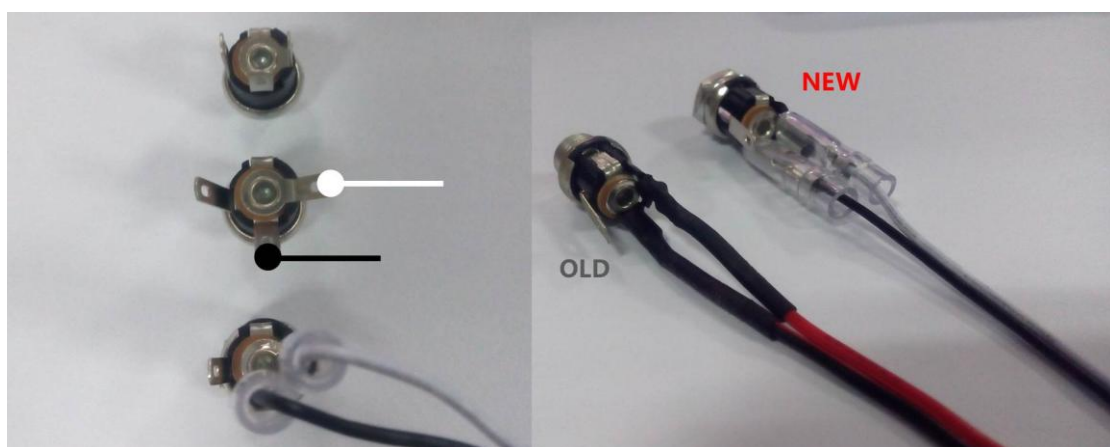

Makeblock Constructor I 3D Printer Kit

Step1. Connect the two wires of 12 V power supply to the corresponding position.

(The red wire is positive and the black wire is negative)

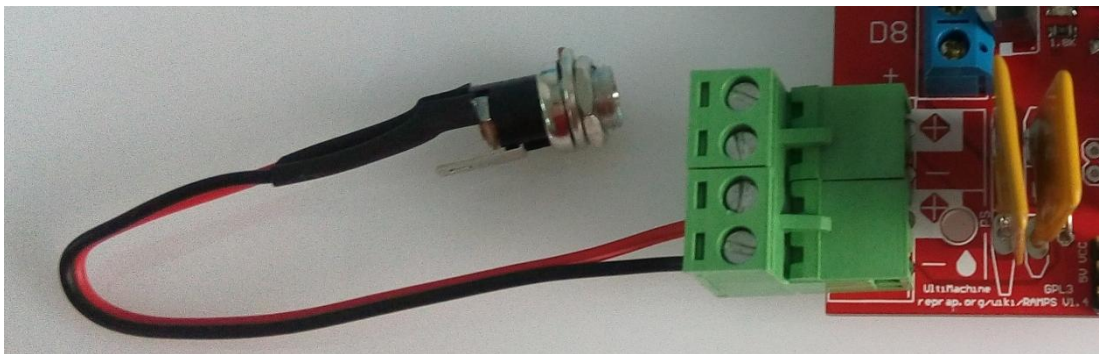
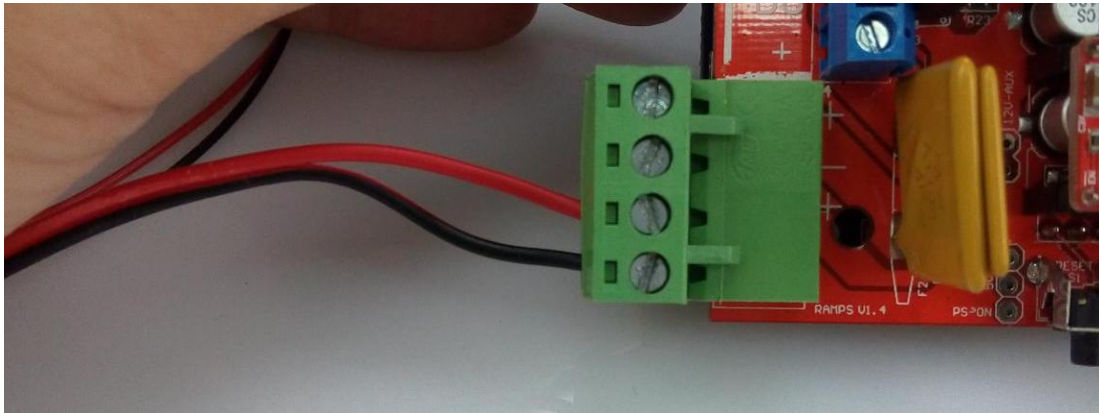

Makeblock Constructor I 3D Printer Kit

Step2. Another group of 12 V power supply required to be connected as shown in below figure. According to positive and negative pole, or the board will burn out.

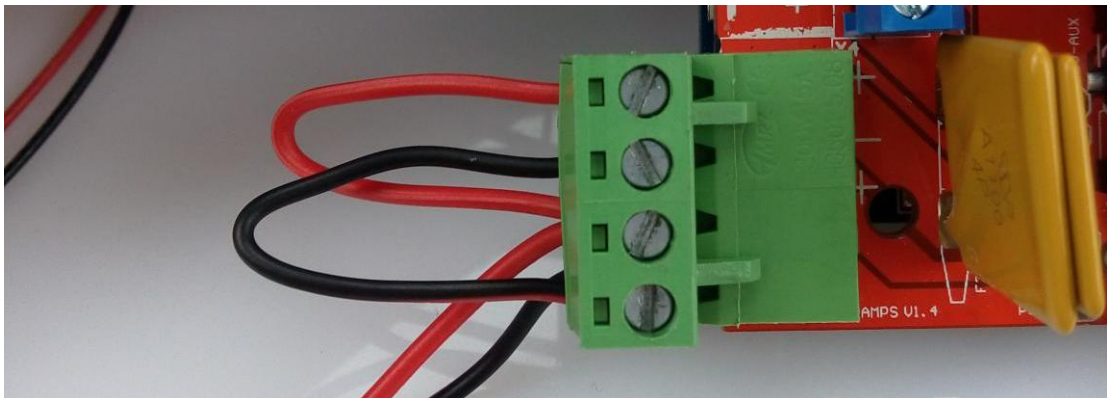
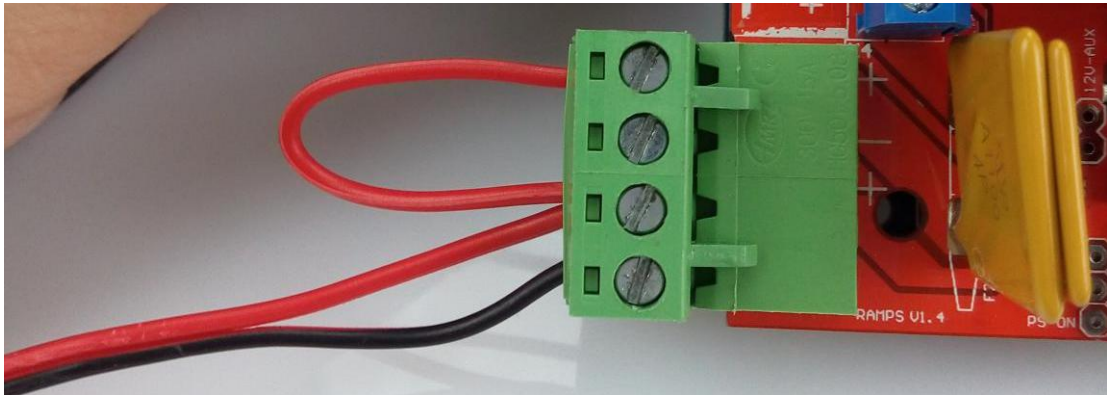

Step3. Connect the extruder fan to the corresponding position as shown in below figure. (The red wire of fan is positive, the black wire is negative.)

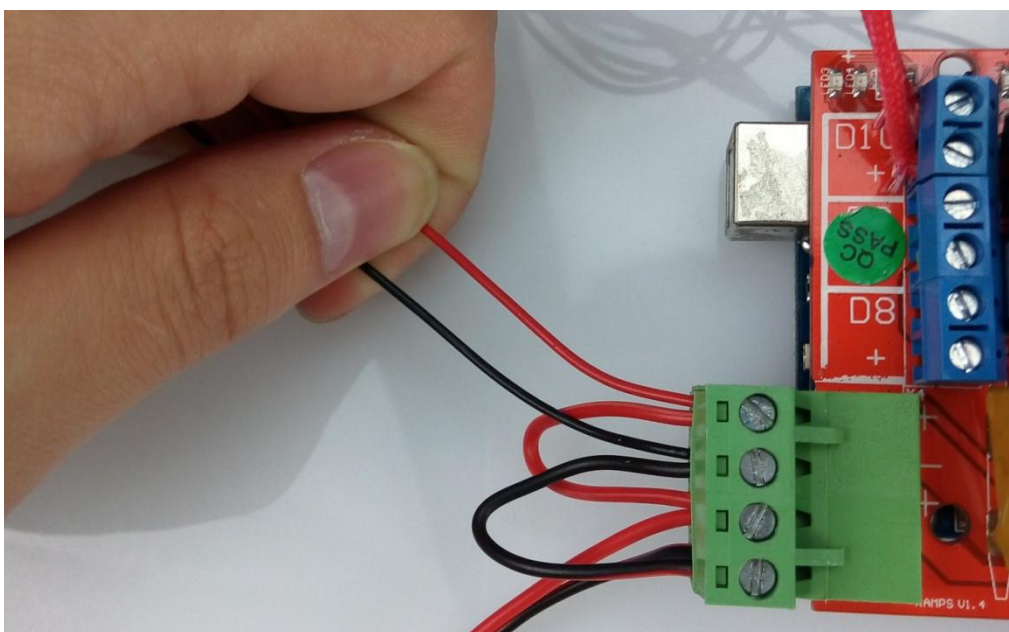

Makeblock Constructor I 3D Printer Kit

Step4. Please double check if you connect all the leads.

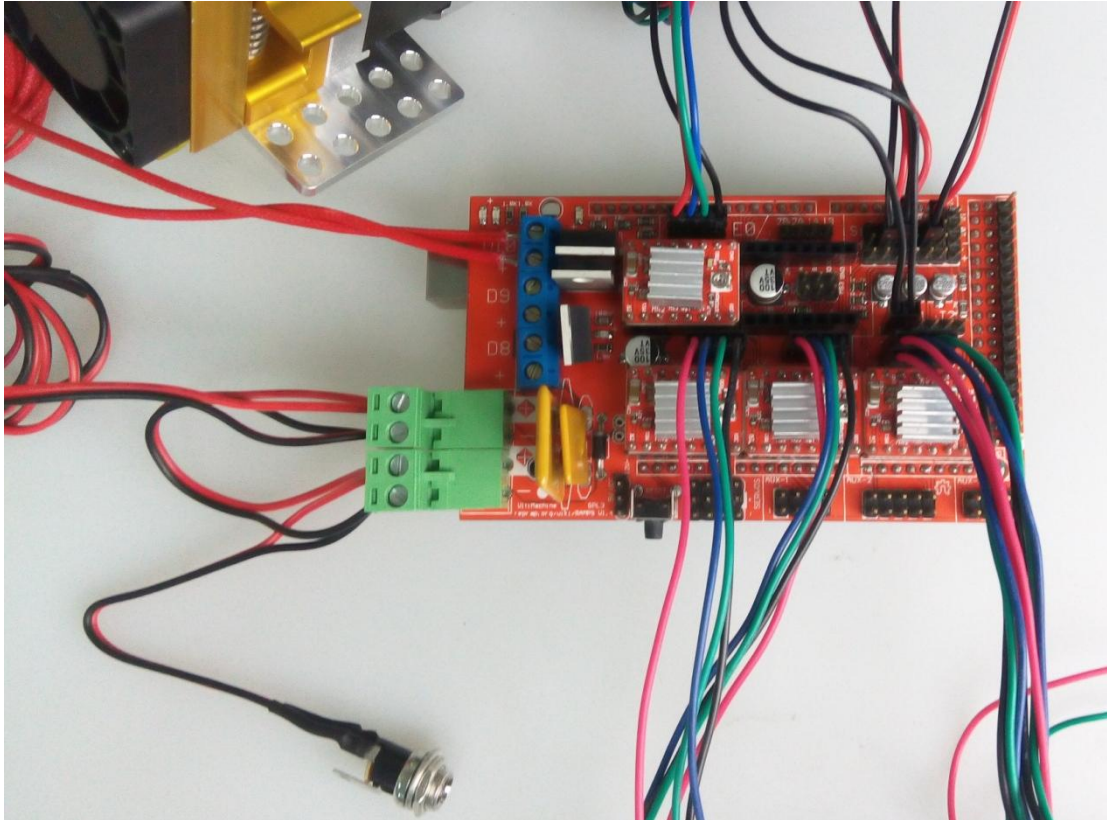

Please confirm as below:

If the stepper motor driver connection is correct?

If the wire connection of stepper motor order is red, blue, green and black?

If the end stop X/Y/Z connection is in correct position?

If the extruder temperature resistor is connect to T0?

If the extruder heating wire is connect to D10?

If the extruder fan connection is correct?

If the power is connection like red to positive and black to negative?